



Integra[®] MicroFrance[®]
Integra ENT - Nose catalogue

Table of contents	ii	Double-ended rasp, 210 mm	36
Warranty and Customer Service Information	iv	Other Rasps	37
Indications / Contraindications	v	Nasal splint, cartilage template	38
Diagnosis	2-3	Crushing press, Perforator bone forceps	39
Air bag	2	Punch rongeur forceps	40
Angled probe caustic holder	3	Double-action rongeur	41-42
Blunt hook	3	Double-action bone rongeur	43
Cotton carrier	3	Septum forceps	44
Diagnostic device	2	Small scissors, pointed blades, matt finish	45
Electrode Cautery	2	Small scissors, pointed blades	46
Eustachian catheter probe	2	Long scissors, pointed blades	47
Screws speculum	2	Small scissors, blunt blades, matt finish	48
Spring speculum	2	Small scissors, blunt blades	49
Speculum with handle	4	Long scissors, blunt blades	50
Speculum with handle - Fiberoptic	5	Small Metzenbaum scissors, matt finish	51
Flexible tension arm	6	Mayo scissors, beveled blades, matt finish	52
Angled dissecting forceps	7	Angled scissors, dorsal scissors, lower lateral scissors	53
Angled forceps	8	Dural scissors - Scissors, serrated blades	54
Syringe	9	Fine dissecting forceps	55
Elevator, raspatory	10-11	Adson dissecting forceps	56
Suction tube elevator	12-13	Medium dissecting forceps	57-58
Scalpel	14	Dissecting forceps, 180mm	59-60
Knife	15	Dissecting forceps, 200mm	61
Raspatory	16-17	Medium bipolar dissecting forceps	62
Retractor	18-23	Medium monopolar dissecting forceps	63
Curette	24-25	Tungsten needle-holder	64
Mallet	26-27	Fine haemostatic forceps	65
Chisel - Gouge	28	Medium haemostatic forceps	66
Osteotome	29	Haemostatic forceps, serrated jaws - Forceps with teeth	67
Guarded osteotome	30	Forceps with teeth	68
Double guarded osteotome	31	Suction tube with finger control	69
Fine osteotome	32	Micro suction tube - adapters	70
Other osteotomes	33		
Straight rasp	34		
Curved rasp	35		

Blunt suction tube	71-72	Levine orbital instrumentation	101
Frazier suction irrigation system	73	Wormald frontal instrumentation	102
Dessi electric irrigation pump accessories	74	Wormald skull base instrumentation	103-104
Irrigation tubing	74	Stamm skull base instrumentation	105
Sleeve for telescope	74	Sterilization case, tray, cup, Surgical oil	106
Irrigation tube, trocar	75	Numerical index	107
Displacer elevator	76	Table for corresponding manufacturer part numbers For information purposes only	113
Seeker, pick	77		
Knife - Elevator	78		
Dissector and knife	78		
Knife	78		
Sickle knife	78		
Fenestrated cup forceps	79		
De Gabory cup forceps	80		
Jankowski cup forceps	81		
Rouvier cup forceps	82		
Weil-Blakesley cup forceps	83		
Pediatric cup forceps	84		
Fenestrated cup forceps	85		
Cup forceps, curved down	86		
Backbiting punch forceps	87		
Pediatric backbiting punch forceps	88		
Micro punch forceps	89		
Micro fine punch cutting forceps	90		
Micro punch rongeur	91		
Nasal sinus scissors - Scissors, serrated blades	92		
Clip applier	93		
Micro bipolar forceps	94		
Micro bipolar forceps with suction	95		
Micro monopolar instruments	96		
Lemoine , Klossek, Kennedy instruments	97		
Vaughan Instruments	98		
Parsons Instruments	99		
Duncavage Instruments	100		

Integra Limited Warranty

Please refer to the warranty included in the packaging of each product to know the applicable warranty.

Contacts Customer service:

International

+33 (0) 4 37 47 59 50
+33 (0) 4 37 47 59 25 (fax)
csemea@integralife.com

France

+33 (0) 4 37 47 59 10
+33 (0) 4 37 47 59 29 (Fax)
custservfrance@integralife.com

Belgium & Luxembourg

+32 (0) 2 257 4130
+32 (0) 2 253 2466 (Fax)
custsvcbenelux@integralife.com

United Kingdom

+44 (0) 1264 312 725
+44 (0) 1264 312 821 (Fax)
custsvcs.uk@integralife.com

Netherlands

+31(0) 852 083 167
+31(0) 207 093 627 (Fax)
custsvcnetherlands@integralife.com

Italy

+39 (0) 2 577 8921
+39 (0) 2 575 113 71 (Fax)
custsvcitaly@integralife.com

MicroFrance® ENT Instrumentation

INDICATIONS

- All the medical devices showed in this catalogue have indications for diagnosis and/or ENT surgery.
- Sizes are not contractual and are given for information purposes only.

CONTRAINDICATIONS

- Do not use in indications other than the indications mentioned in the DFU or Labeling.

How to read the catalogue

Diagnosis

INTEGRA

Detail view of the instrument

Instrument to a 1/1 scale except mentioned otherwise

Explanatory table see below

Blunt hook 90°		Blunt hook 45°		Cotton carrier/twist end		Angled probe caustic holder	
MCO805	160mm	MCO807	160mm	7719-2	140mm	7731	110mm
2mm	2,5mm	1mm		Ø 1,2mm			working length 80mm

DOCUMENT FOR USE IN EUROPE, MIDDLE-EAST AND AFRICA ONLY.

Explanation of the table reference and complementary product description

Title or subtitles	
global complementary description	
Product Ref.1	complementary description1
Product Ref.2	complementary description2

Electrode cautery



Eustachian catheter probe



Spring speculum, screws speculum

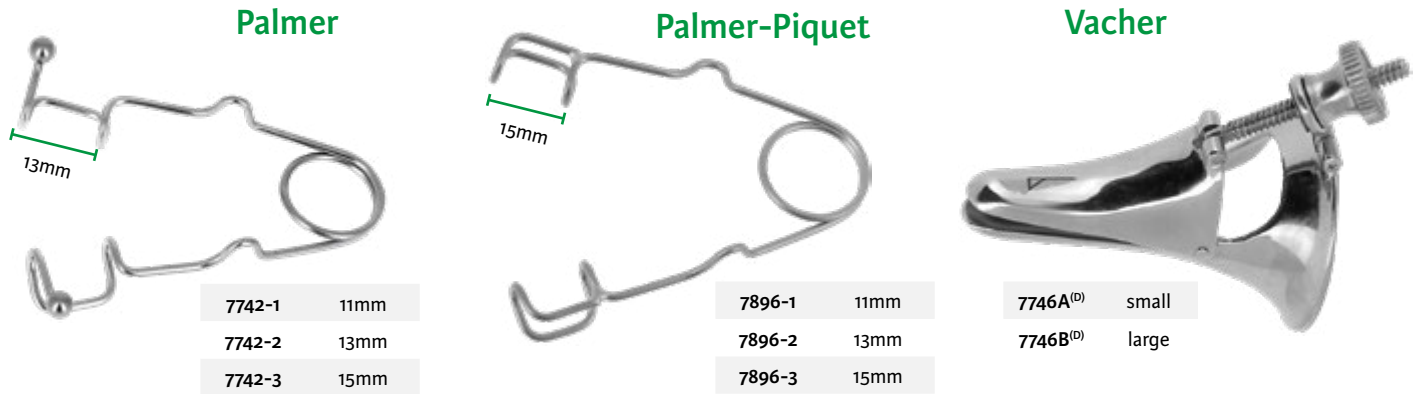

Diagnostic device



Air bag



^(D) Distributed by Integra MicroFrance SAS (France) - For corresponding manufacturer part numbers, see table in annex

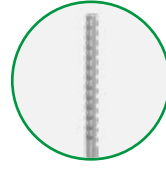
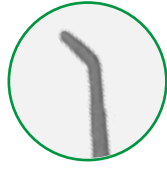

Marquet

Legent



Blunt hook
90°

Blunt hook
45°

Cotton carrier, twist end
15mm

Angled probe caustic
holder

165mm

165mm

140mm

110mm

MCO805

MCO805A

MCO950

MCO807

7719-2

7731

2mm

2.5mm

0.8mm

1mm

Ø 1.2mm

working length 80mm

Hartmann



160mm
7898

Tieck-Halle



130mm
7897

Beckman



140mm
7899
Left hand

Vienna



140mm
MCO233
Dilatator



140mm
MCO237
Self-retaining
Serrated blades

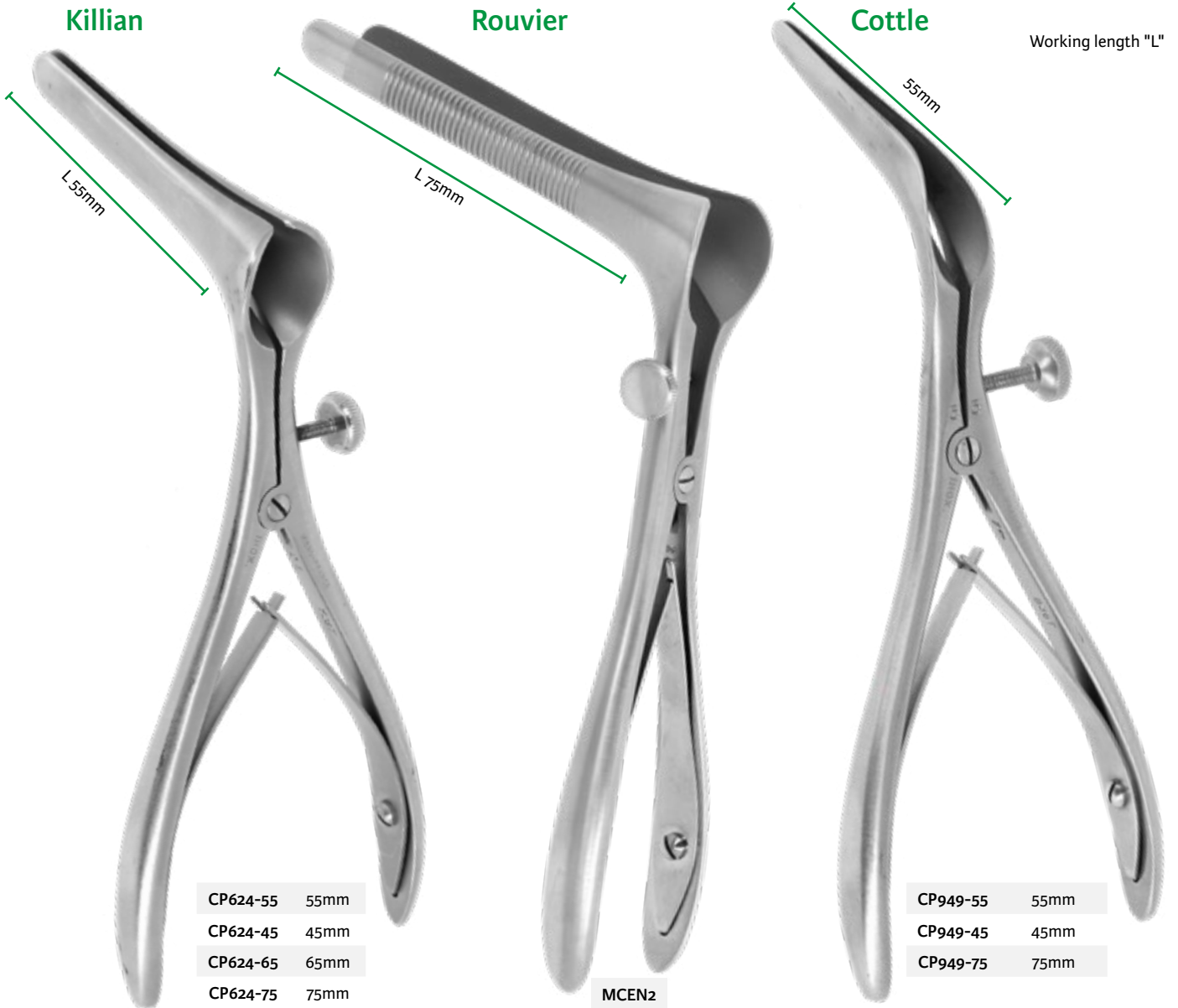

Self-retaining speculum with fiber optic - Fiberoptic 220cm - Adapters



Storz

MCL75



Adapters	for generator	for instrument
Wolf	MCL170 ^{(D)(t)}	MCL171 ^{(D)(t)}
Storz	MCL173 ^{(D)(t)}	MCL174 ^{(D)(t)}
Olympus	MCL197 ^{(D)(t)}	

^(t) Not a medical device

^(D) Distributed by Integra MicroFrance SAS (France) - For corresponding manufacturer part numbers, see table in annex

Flexible tension arm

Legent



Complete flexible tension arm

MCO980

Delivered with MCO981



Darrouzet

Complete flexible tension arm

MCO978

Delivered with MCO978S

Operating room table clamp

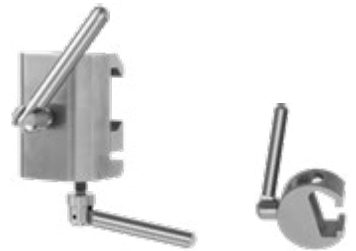

CEV984

CEV985

Accessories for flexible tension arm

Ear quick-lock speculum

Articulated kneecap

Self-retaining specula



MCO981



MCO983-4



Devèze

MCO981D



MCO978S

Lucae



7726MF

Politzer



7732-1

150mm

7726MF	7727	7728
serrated jaws 1x12mm	spoon jaws	with teeth

120mm

7732-1	7733	7734
serrated jaws 1,5x14mm	spoon jaws	with teeth

Angled forceps

Scale 1/2

Serrated jaws

Rouvier

Pradès



MCEN18

MCEN19

3x8mm

0.9x7mm

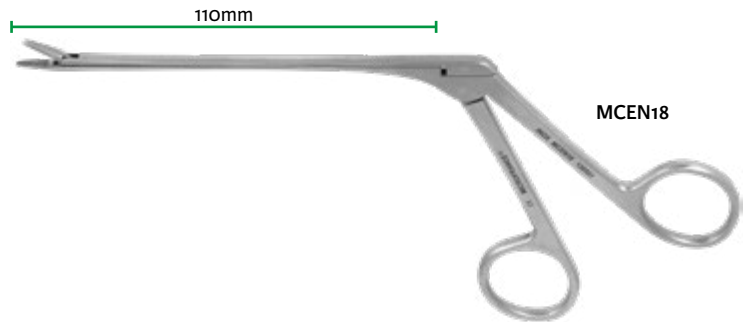

MCEN18

Lubet-Barbon

Jaws 60mm

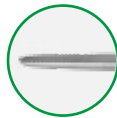
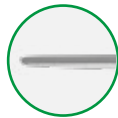

7749

7750

smooth jaws

serrated jaws

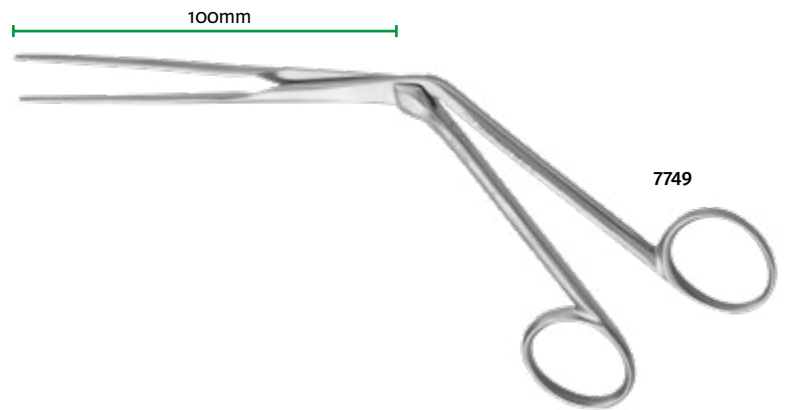

7749

Spoon jaws forceps

Brünings

Spoon jaws

Fenestrated spoon jaws



7761-1

7761-2

7761B-1

7761B-2

7.5mm

9.5mm

7.5mm

9.5mm

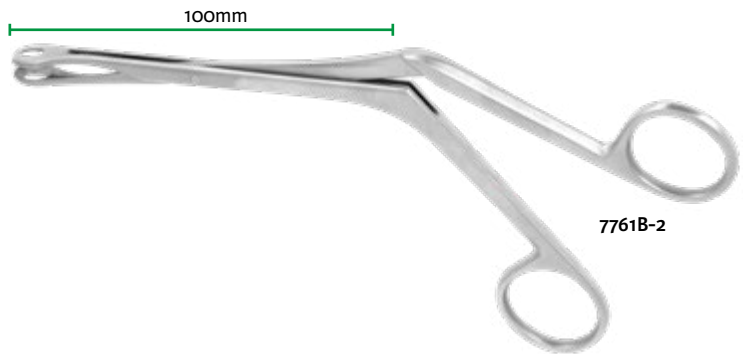

7761B-2

Luc

Spoon jaws

Fenestrated spoon jaws

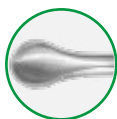

7761C1

7761C2

7761C3

7761BC1

7761BC2

7761BC3

7mm

9mm

11mm

7mm

9mm

11mm

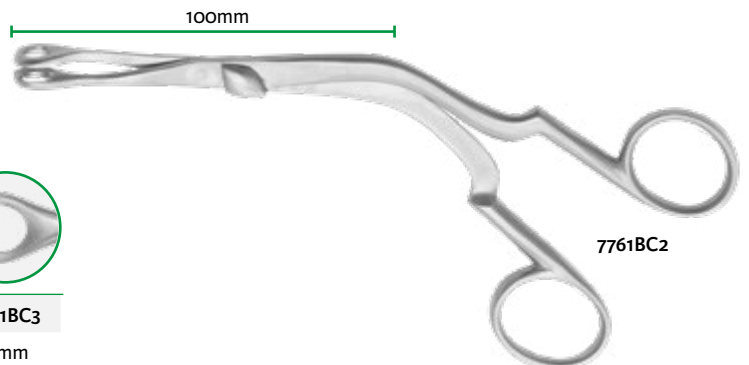

7761BC2

Syringe

Génia

Injection needle

7903-50-5^(D)

50mm - Ø 0,5mm

Pack 12

Delivered with syringe

7779MF-5CC

Syringe high pressure
luer-lock 5cc

Delivered with a box of 12 needles
ref. 7903-50-5

Grey washer luer

7779MF-2

Pack 6

Replacement tube

7779MF-3

White washer piston

7779MF-1

Pack 6

Pushing syringe

7783-12

Pack 2

Chouard

for syringe, single use, luer-lock 12cc

Injection needle

7903-50-5^(D)

50mm - Ø 0,5mm

Pack 12

for syringe 7779MF-5CC

^(D) Distributed by Integra MicroFrance SAS (France) - For corresponding manufacturer part numbers, see table in annex

Sébileau



190mm
CP985
5mm

Fleury



180mm
MCO305
8,5mm

Freer



185mm
CP611
5mm

Howarth



220mm
CP625

Cottle



220mm
CP626

McKenty



240mm
CP627

Rouvier

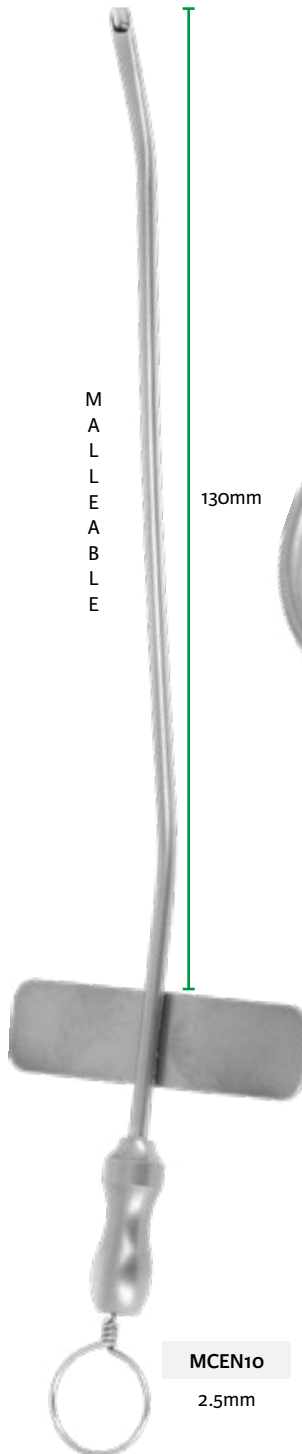

MCEN10
2.5mm

Orsel

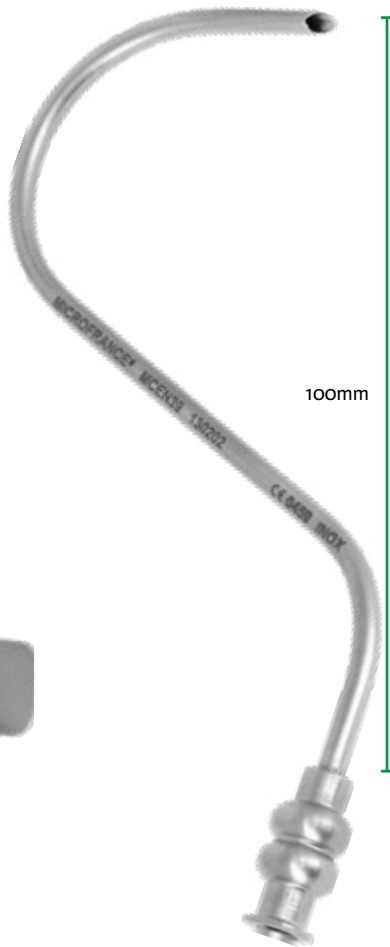

MCEN39
3mm

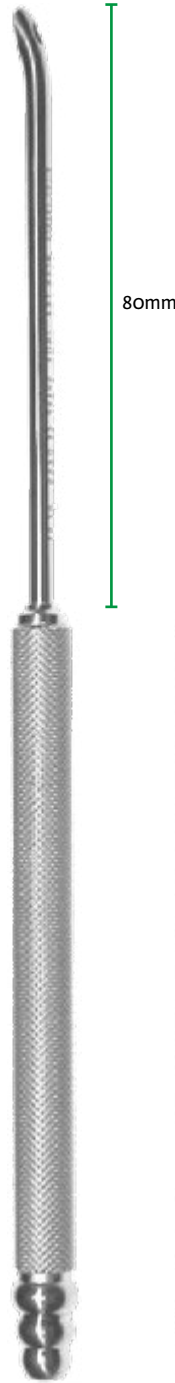

MCEN764
3.5mm
sharp

MCEN765
3.5mm
blunt

Orsel

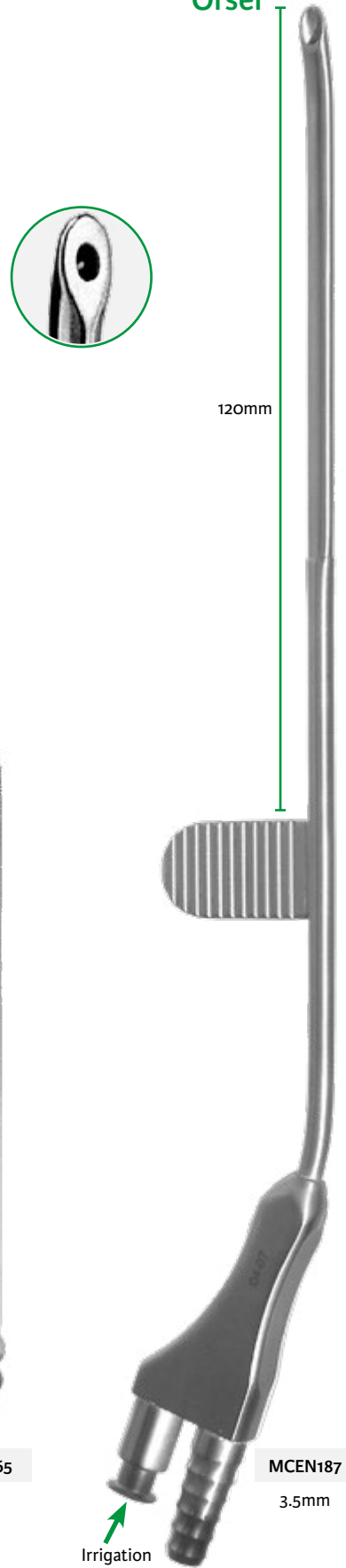

MCEN187
3.5mm
Irrigation

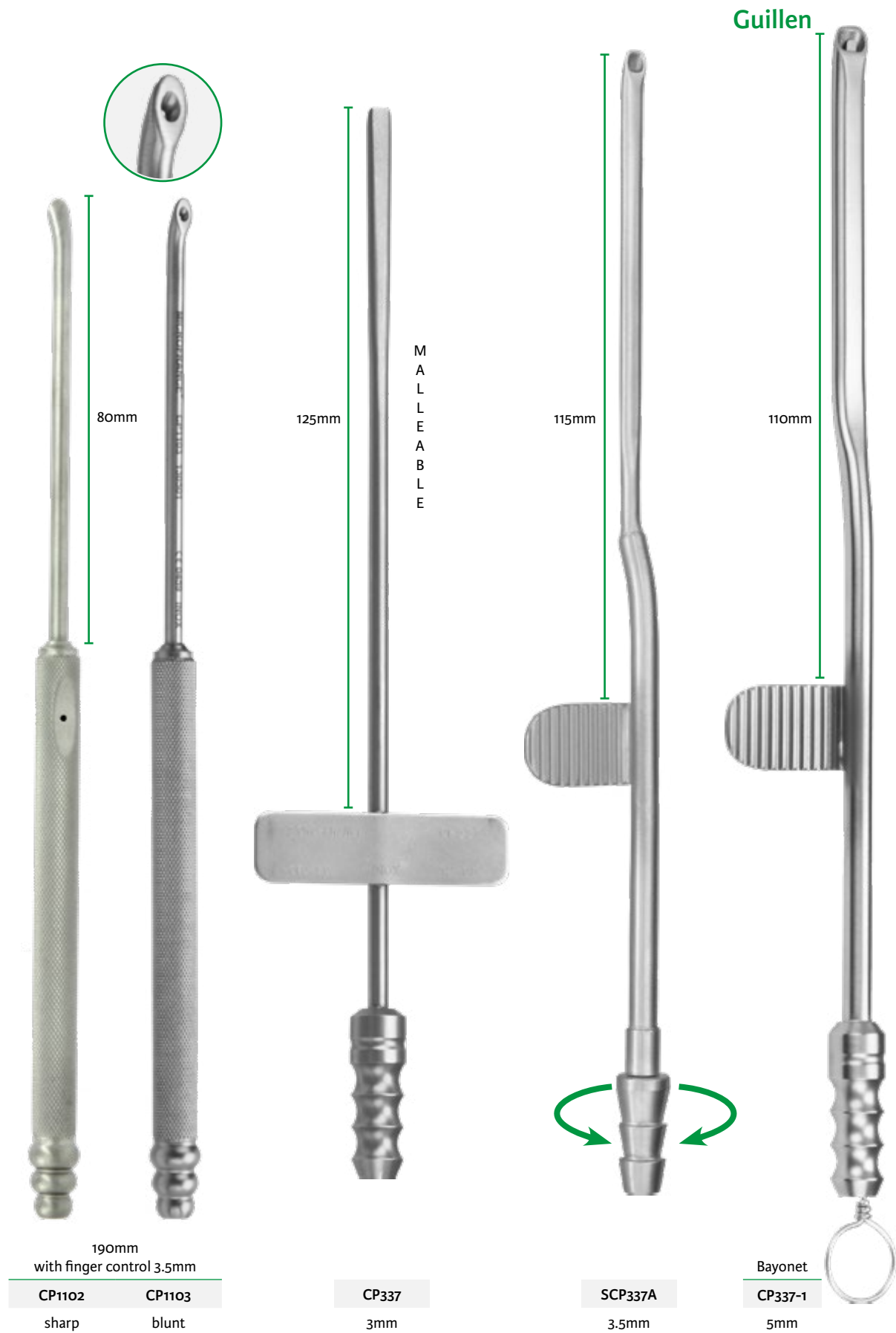



120mm

1003IG^(D)

N° 3



160mm

1005I^(D)

N° 7



200mm

1003LI^(D)

N° 3L



150mm

CP821



120mm

1004IG^(D)

N° 4

blades 23

use with blades 11/15

^(D) Distributed by Integra MicroFrance SAS (France) - For corresponding manufacturer part numbers, see table in annex

Ballenger



200mm
CP622-4 4mm
215mm
3714164 3mm
3714166 5mm

Joseph



160mm
CP333 angled

Joseph



160mm
3714678
7mm

Farabeuf

Fleury

Sébileau

Plester



150mm

7787-10

10mm



170mm

MCO979

6,5mm



150mm

CP825

4mm



180mm

MCO988

7,5mm



195mm

3724059

6,5mm

Joseph



180mm

CP310

5mm

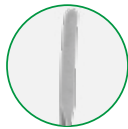

180mm

CP310D

5mm
Straight

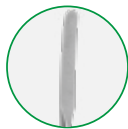

180mm

CP310E

4mm

CP310

Obwegeser



Obwegeser

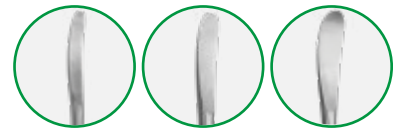

180mm

CP344A

5mm

CP344B

7mm

CP344C

11mm

Obwegeser-Tessier

180mm - sharp

CP344AT

5mm

CP344BT

7mm

CP344CT

11mm

Obwegeser



190mm

CP344D

7mm
Curved

CP344E

7mm
Very curved

Obwegeser-Tessier

190mm - sharp

CP344DT

7mm
Curved

CP344ET

7mm
Very curved

CP344A

Farabeuf



140mm	120mm
7768-1	7768
pair	pair

Desmarres



140mm
CP822-12
12mm
CP822-10
10mm
CP822-14
14mm

Gillies



180mm
CP17
3mm
CP17-1
2mm

Gillies



145mm
CP17-3
2mm
CP17-2
3mm



145mm
CP628
5mm

Humby



110mm
CP941
articulated

Kleinert-Kutz



160mm

- 3714024 3mm
- 3714025 5mm
- 3714026 7mm

Cottle



145mm

- 3714107 4mm
- very curved
- 3714108 4mm
- 3714109 5mm

Sisson



150mm

- 3714111 6mm

Converse



180mm

- 3714364 2,5mm

Frazier



130mm

- 3724256 3,5mm

Knapp



150mm

3714027

8mm

3714028

blunt



140mm

CP21-3

sharp

CP21A-3

blunt

Volkmann



150mm

7782-1-2



180mm

CP335

Senn-Miller



160mm

CP609

3 sharp prongs

80mm
CP340

Cloué



110mm
CP341

Converse



95mm
CP331 CP331-1
sharp blunt

Kilner



125mm
CP803

Just



120mm
CP338



130mm
CP339



Aufricht



170mm
CP306 45mm

Cottle



130mm
3714187





Cottle



130mm
3714182 Right tip sharp, left ball tip
3714183 Left tip sharp, right ball tip

Joseph



- 
CP23-4
4mm
- 
CP23-6
6mm
- 
CP23-8
8mm
- 
CP23A-8
8mm
mousse
- 
CP23-10
10mm

160mm
CP23-10
10mm

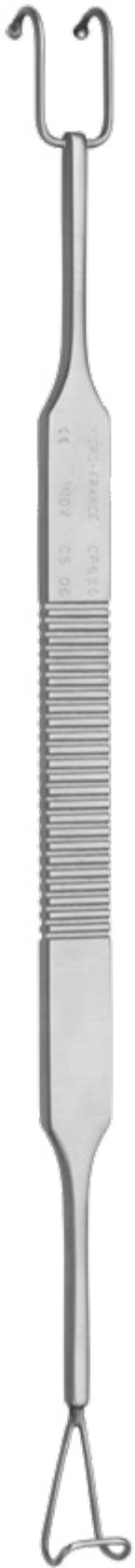

220mm

CP630

with loop
and ball

Ragnell



160mm

CP632

Dufourmentel



170mm

CP947

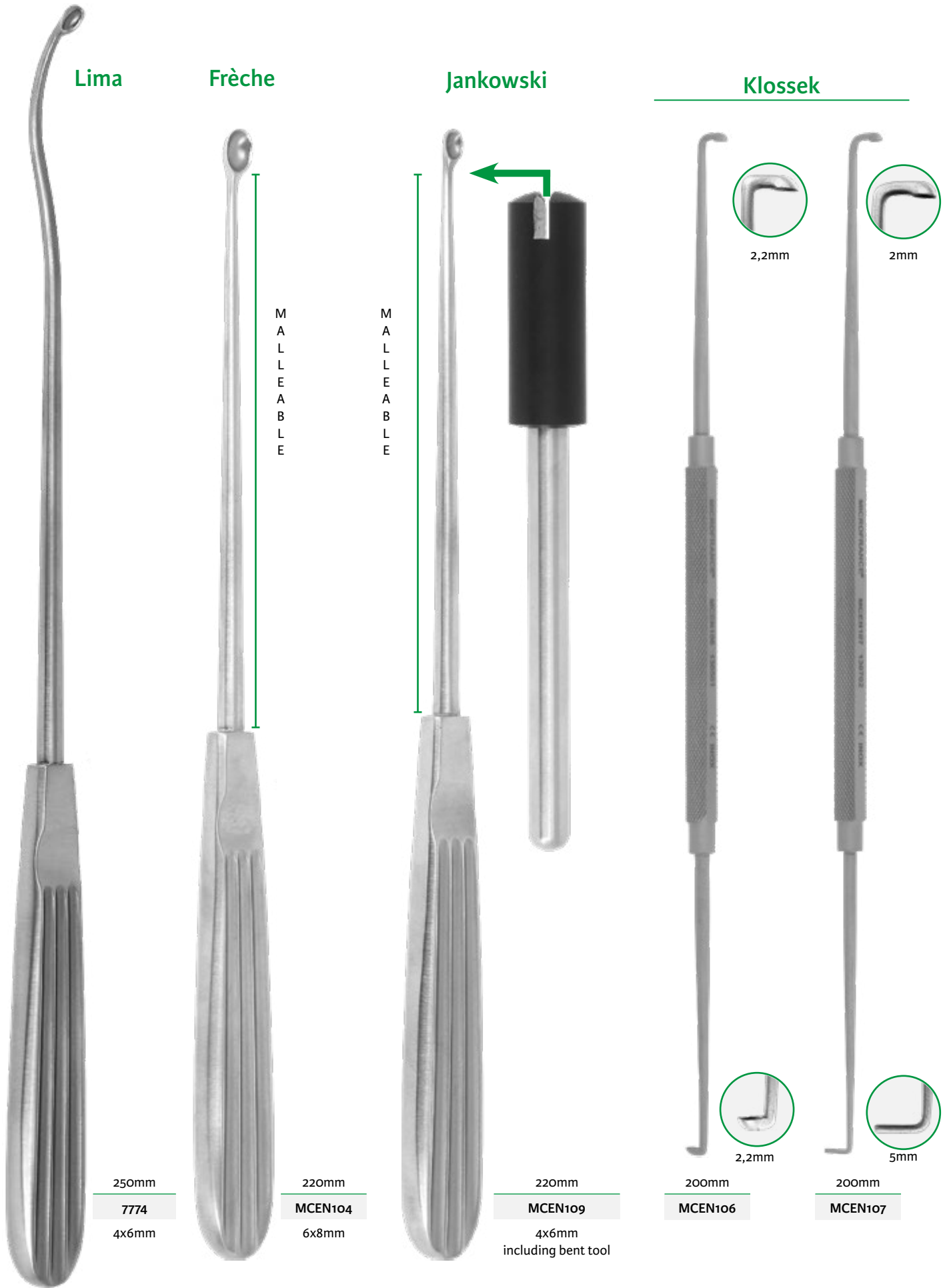

Lima

Frèche

Jankowski

Klossek

M
A
L
L
E
A
B
L
E

M
A
L
L
E
A
B
L
E

250mm
774
4x6mm

220mm
MCEN104
6x8mm

220mm
MCEN109
4x6mm
including bent tool

200mm
MCEN106

200mm
MCEN107

2,2mm

2mm

2,2mm

5mm

Scale 1/1

Straight curette

Volkman



CP302-6

170mm								
0	CP302-2	2mm	0	CP302-4	4mm	0	CP302-6	6mm
0	CP302-3	3mm	0	CP302-5	5mm	0	CP302-8	8mm



165mm - 110g

MCO995

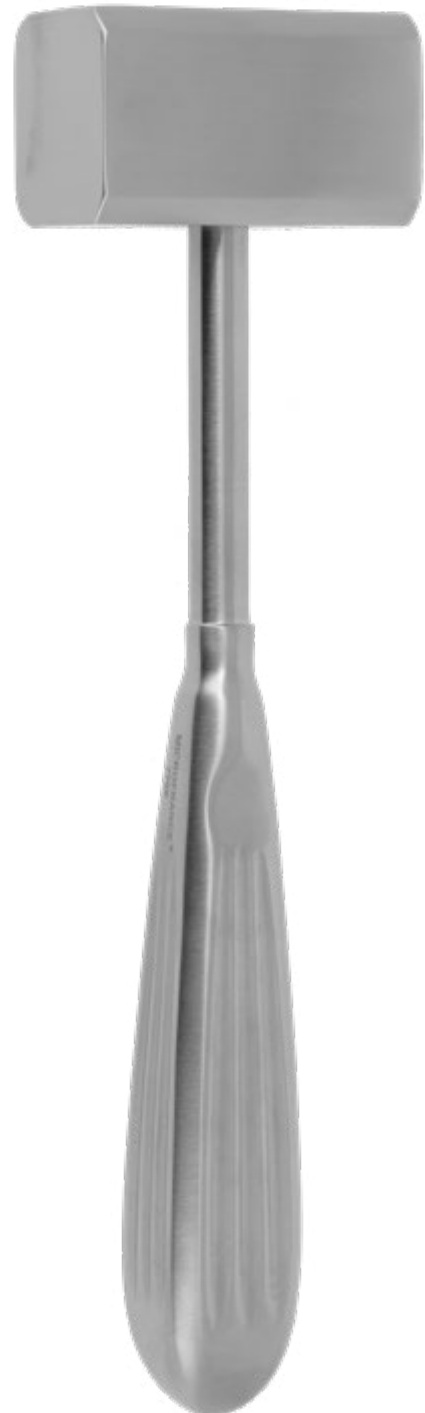

Lombard

185mm - 330g

7766



180mm - 200g

CP907

1 teflon head



180mm - 230g

CP300

Jost

Ballenger

Metzenbaum

Fleury

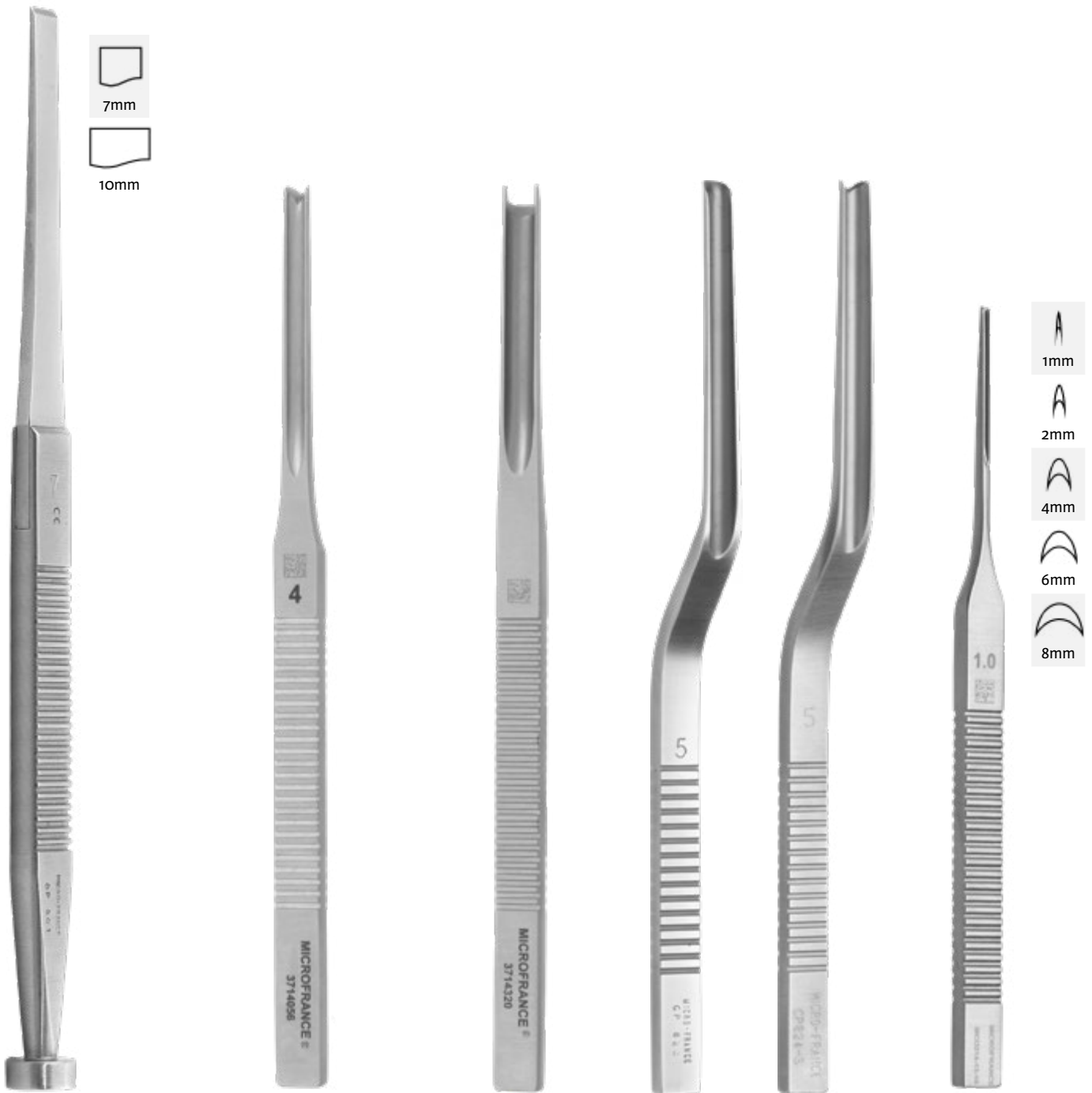

Chisel

Gouge

Straight

Straight 'V' shaped

Bayonet

Bayonet 'V' shaped

Straight

180mm

150mm

150mm

150mm

150mm

130mm

CP801-7	7mm
CP801-10	10mm

3714055	2mm
3714056	4mm
3714057	6mm
3714058	8mm

3714320	5mm
---------	-----

CP823-5	5mm
---------	-----

CP824-5	5mm
---------	-----

MCO214-13-10	1mm
MCO214-13-20	2mm
MCO214-13-40	4mm
MCO214-13-60	6mm
MCO214-13-80	8mm

Aiach



160mm

CP317

16mm

Pollet-Pech



160mm

CP318

13mm

Marchac



180mm

CP304-10

Size	Curved	Straight
 2mm	CP304B-2	CP304-2
 3mm	CP304B-3	CP304-3
 4mm	CP304B-4	CP304-4
 5mm	CP304B-5	CP304-5
 6mm	CP304B-6	CP304-6
 7mm	-	CP304-7
 8mm	CP304B-8	CP304-8
 9mm	-	CP304-9
 10mm	CP304B-10	CP304-10
 11mm	-	CP304-11
 12mm	CP304B-12	CP304-12
 14mm	-	CP304-14
 15mm	-	CP304-15
 16mm	-	CP304-16

Tessier

Jost

Marchac

Claoué

Silver



180mm

CP316



180mm

CP802



180mm

CP315



CP315

Pech-Marchac



CP315D

curved right



CP315G

curved left



180mm

CP305

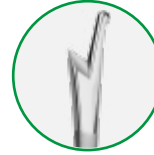

CP305

Lindas

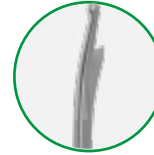

CP305L

curved left

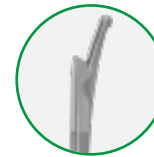

CP305R

curved right



3714098

curved right



3714099

curved left



180mm

3714098

Mac-Indoe



180mm
CP314-14
14mm

Robin



160mm
CP309-14-16



CP309-8-12
8 - 12mm



CP309-10-14
10 - 14mm



CP309-12-16
12 - 16mm



CP309-14-16
14 - 16mm



CP309-14-18
14 - 18mm

Cottle



195mm
CP808-6
6mm

Cottle



195mm
CP806
6mm

Cottle



190mm
CP807
5mm

Becker

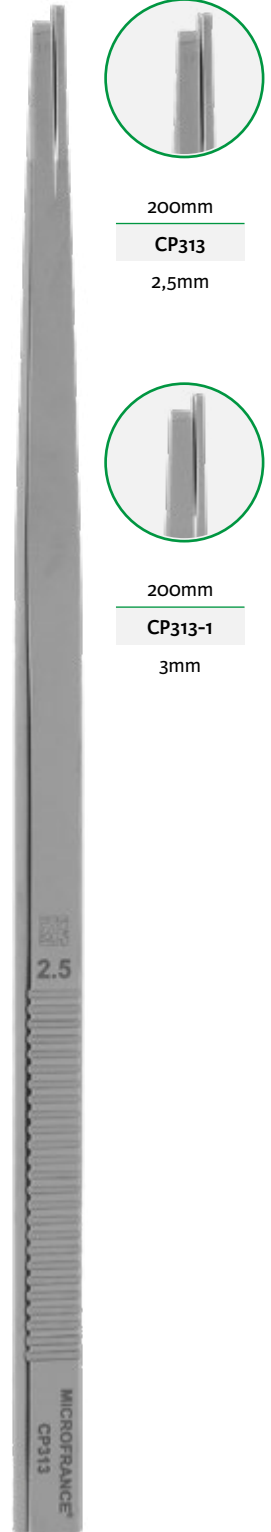

200mm
CP313

Parkès



170mm

3714096

4mm

Maltz



170mm
CP301-1

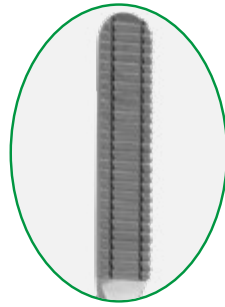

Maltz

CP301-1

8x35mm - downstroke

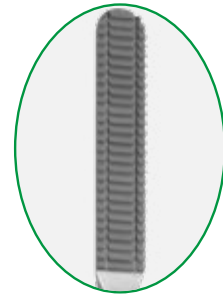

Maltz

CP301

10x45mm - downstroke

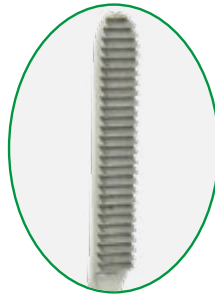

170mm

CP905

8x35mm, downcutting,
concave

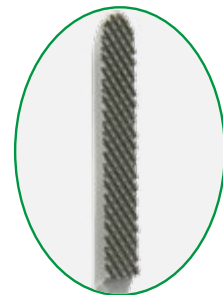

170mm

CP828

8x35mm - downstroke



170mm

CP978

8x35mm, straight, coarse

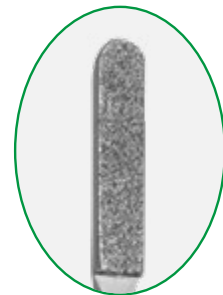

180mm

CP810

8x30mm, straight, diamond

Aufricht

200mm



CP973

8x25mm
downward
cutting



CP974

8x25mm
upward cutting

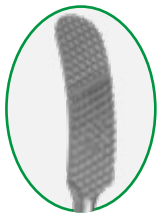

CP976

8x30mm
bi-directional



200mm

CP1100

8x8mm

Bigot



200mm

CP291

4x15mm



190mm

CP998-1

8x12mm
cross-cutting

Fomon



180mm

CP809

8x30mm
diamond



175mm

CP301-3

7x20mm
concave
downward
cutting



180mm

CP301-2

8x30mm
downward cutting

Becker

Becker

Fomon

Rees

Gorney

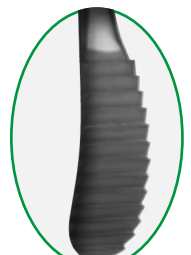
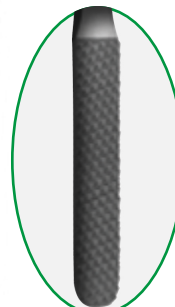

CP301-10
7x38mm-7/8
Sure-Grip™
tungsten

CP1104
7x20mm-1/2
Sure-Grip™
tungsten

CP1105
7x20mm-3/4
Sure-Grip™
tungsten

CP301-4
7x38mm
coarse

CP301-5
7x38mm
coarse

CP301-9
7x12mm
8x22mm

Fomon



210mm

Double-ended
one convex
one flat
coarse teeth

3714149 7mm

fine teeth

3714148 7mm

3714149

Aquaplast™ nasal splint

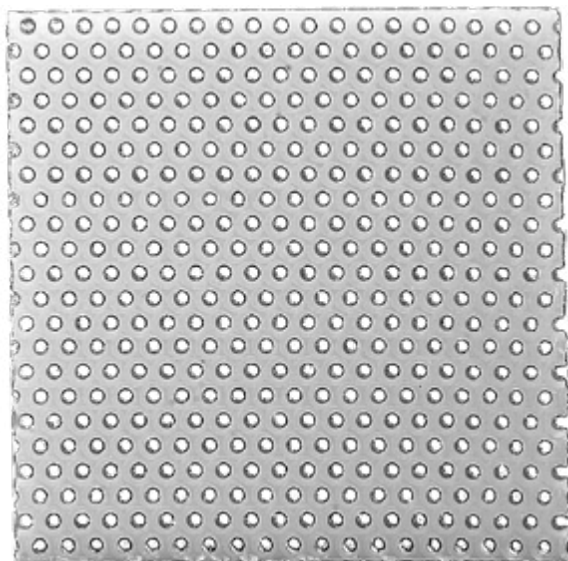

AQ1728^(D)

75x75mm - Pack 10

not sterile, single use

^(D) Distributed by Integra MicroFrance SAS (France)
For corresponding manufacturer part numbers, see table in annex

Cartilage template

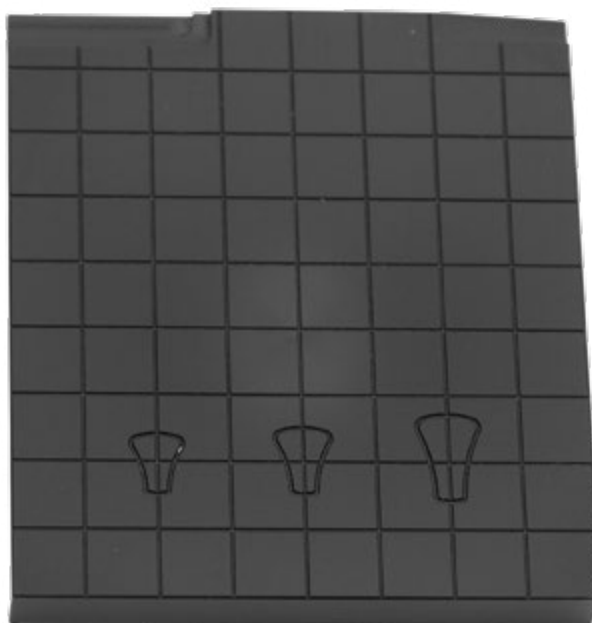

CP1109

80x90mm
with graduations

Scale 1/2

Cartilage crushing press

Jost

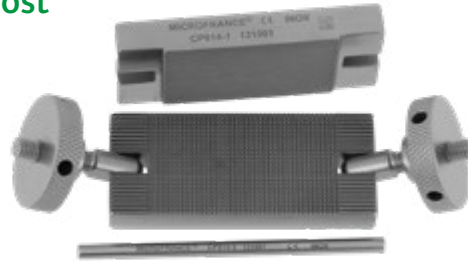

CP814-1

Delivered with key CP814-3



CP814-2

Smooth plate device 30x50mm
for CP814-1



CP814-3

Tightening key
for CP814-1

Scale 1/2

Perforator bone forceps



Stoll



150mm

CP640

Scale 1/2



Beyer



CP380

160mm

CP380	CP380-2
straight jaws 2mm	curved jaws 2mm

Beyer



CP380-3

180mm

CP380-3	CP380-5	CP380-1
curved jaws 2mm	curved jaws 4mm	straight jaws 2mm

Jansen-Middleton



180mm

Double-action rongeur

CP621 4x20mm

Scale 2/3

Double-action bone rongeur

Ruskin



160mm

CP381

Scale 2/3

Martin



240mm

7765

Delivered with 2 jaws

Offret

Scale 3/4



100mm

CP353

strong curvature



100mm

CP356

Streiff

Joseph

Fox



CP16-1

105mm

CP16-1

CP16

Curved blades

Straight blades



CP919A

110mm

CP919A

CP919

Curved blades

Straight blades



CP358A

110mm

CP358A

CP358

Curved blades

Straight blades

Joseph

Kilner-jost



CP354A



120mm - matt finish	
CP354A	CP354
Curved blades	Straight blades

120mm - matt finish
CP362
Curved

Boetcher

Brophy

Joseph



180mm

CP997

Curved



CP367-1

150mm

CP367-1

Curved

CP367

Straight



CP355A

150mm

CP355A

Curved

CP355

Straight

Bregat

Stevens

Stevens



110mm
CP363
Curved blades



110mm - Tenotomy scissors
CP922
Straight blades



110mm - Tenotomy scissors
CP922A
Curved blades

Stevens

Shea

matt finish

matt finish



115mm - Tenotomy scissors

CP922B

Curved blades



120mm

CP637

Curved blades

Reynolds

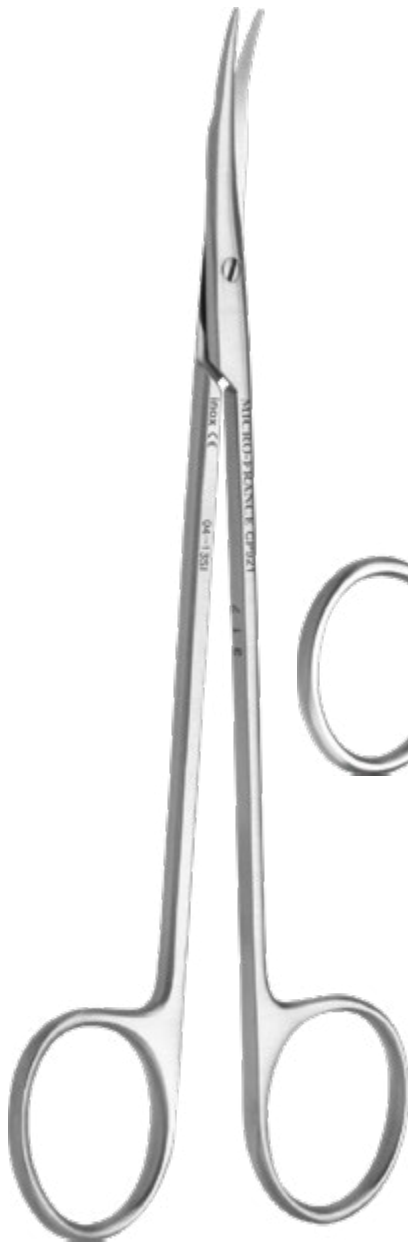

160mm

CP921

Ragnell

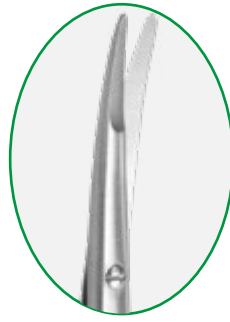

150mm

CP616-15



130mm

CP616-13

Joseph



150mm

CP355C

Léger



150mm

CP365

Metzenbaum



110mm

CP351-7	CP351-6
Curved blades	Straight blades

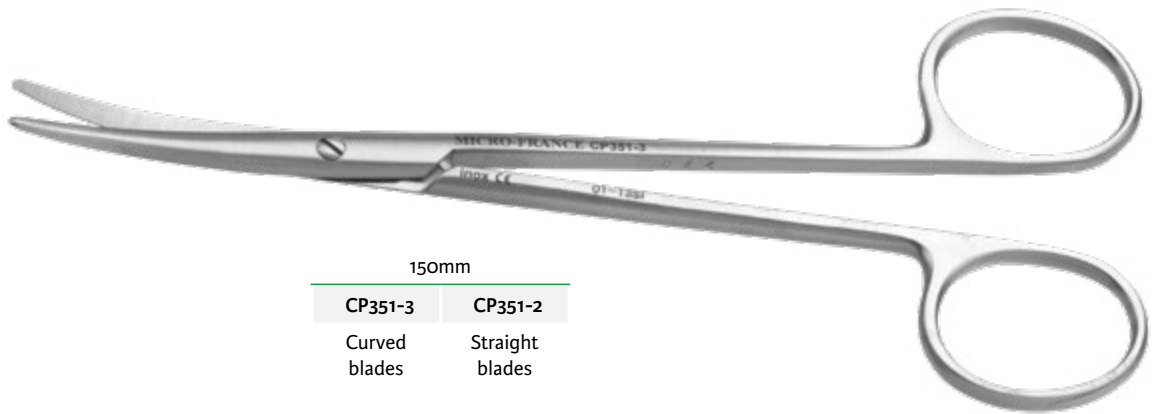

150mm

CP351-3	CP351-2
Curved blades	Straight blades

Delicate curved scissors

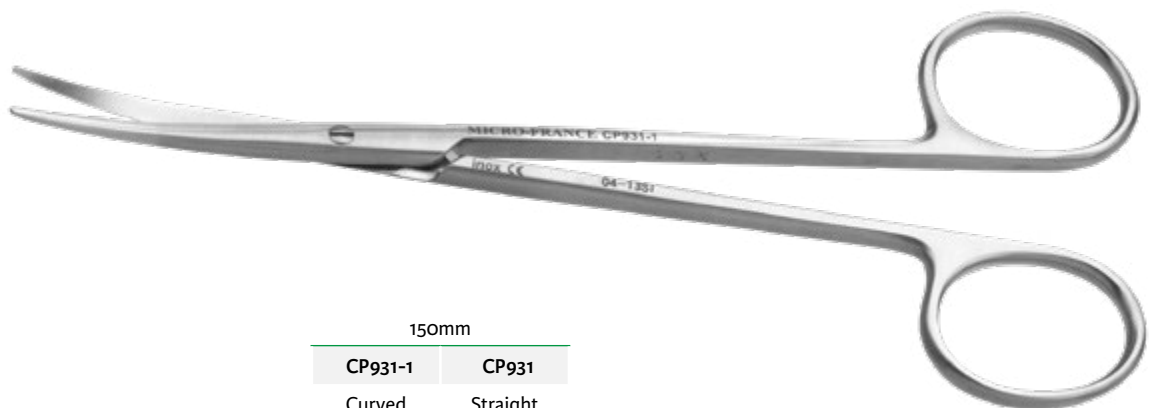

150mm

CP931-1	CP931
Curved blades	Straight blades

Mayo



170mm
CP352-2
Straight blades

150mm
CP352
Straight blades

170mm
CP352-3
Curved blades

150mm
CP352-1
Curved blades

Becker-Converte

100mm
CP1106
Angled scissors
serrated blades



Converte

100mm
CP348
Angled scissors



Fomon

Fomon



140mm
CP612
lower lateral scissors
very curved

Cottle

Pellegrini

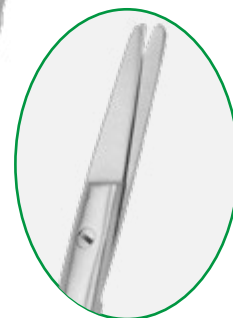

150mm
CP359
dorsal scissors
serrated blades

Cottle-Pech

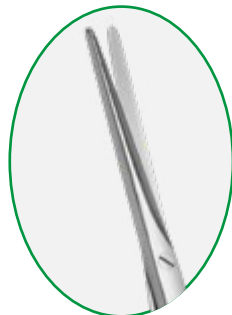

140mm
CP635
dorsal scissors



140mm
CP613
dorsal scissors - blunt tip



150mm
CP614
dorsal scissors

Heymann-Klossek

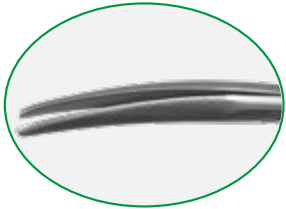
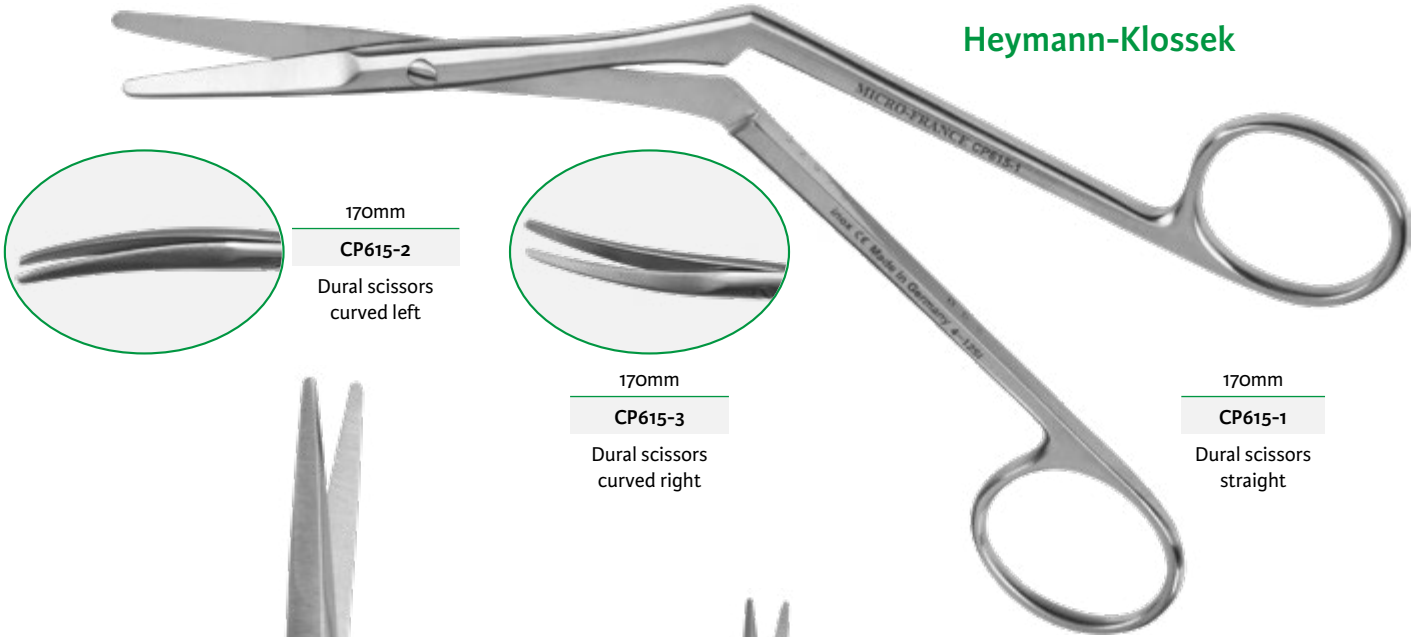

170mm
CP615-2
Dural scissors
curved left



170mm
CP615-3
Dural scissors
curved right

170mm
CP615-1
Dural scissors
straight



180mm
CP350
Straight scissors
serrated bayonet blades

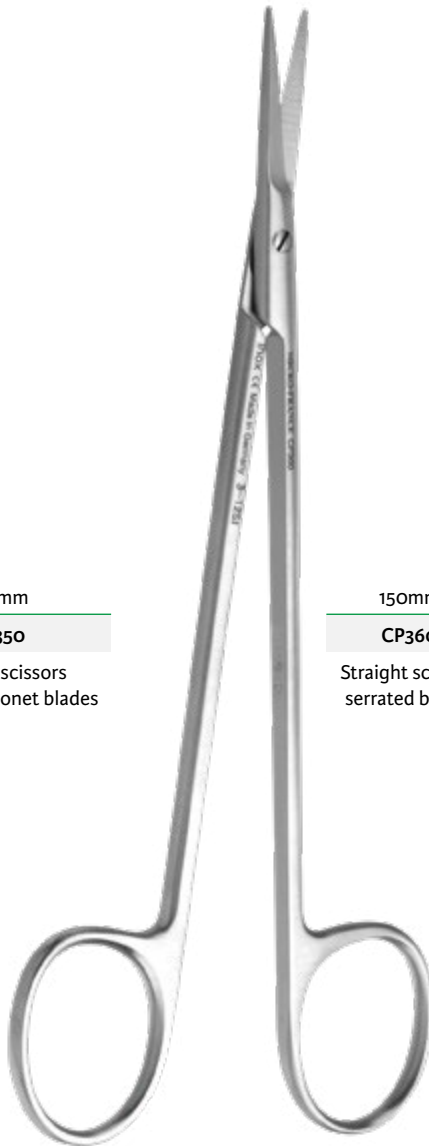

150mm
CP360
Straight scissors
serrated blades

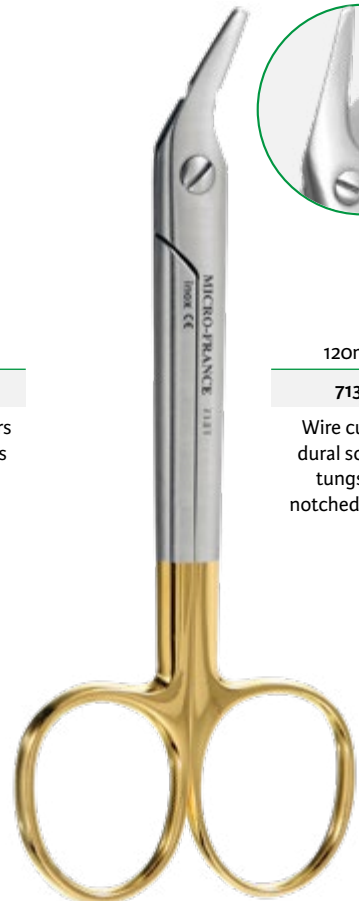

120mm
713T
Wire cutting
dural scissors
tungsten
notched blades



Bebee

Dissecting forceps 110mm

Castroviejo



CP938-1

Horizontal teeth and platform

Castroviejo



CP37

Oblique teeth and platform



CP332

Serrated jaws 1.4mm

Dissecting forceps 120mm



Serrated jaws

CP414

Jaws 1mm



7831A-12

Jaws 1.5mm



CP406

Jaws 1mm



Jaws with teeth

7833A-12

Jaws 1.5mm



CP400-1

5X5 teeth

150mm

Adson



CP604-15 Serrated jaws 1.5mm
CP605-15 1x2 teeth jaws 1.5mm

Adson-Brown



CP606-15 7x7 teeth

120mm



Adson-Tubiana

Jaws 1mm

M832	M833
serrated jaws	1x2 teeth

Jaws 1,5mm

CP604	CP605
serrated jaws	1x2 teeth

Adson

Jaws 1,5mm

CP606A
tungsten serrated jaws

Adson-Brown

Jaws with 7x7 teeth

CP606

Mac-Indoe

140mm



CP934 Oblique teeth and serrated platform

CP934-1 Serrated jaws

Debakey

Barraya

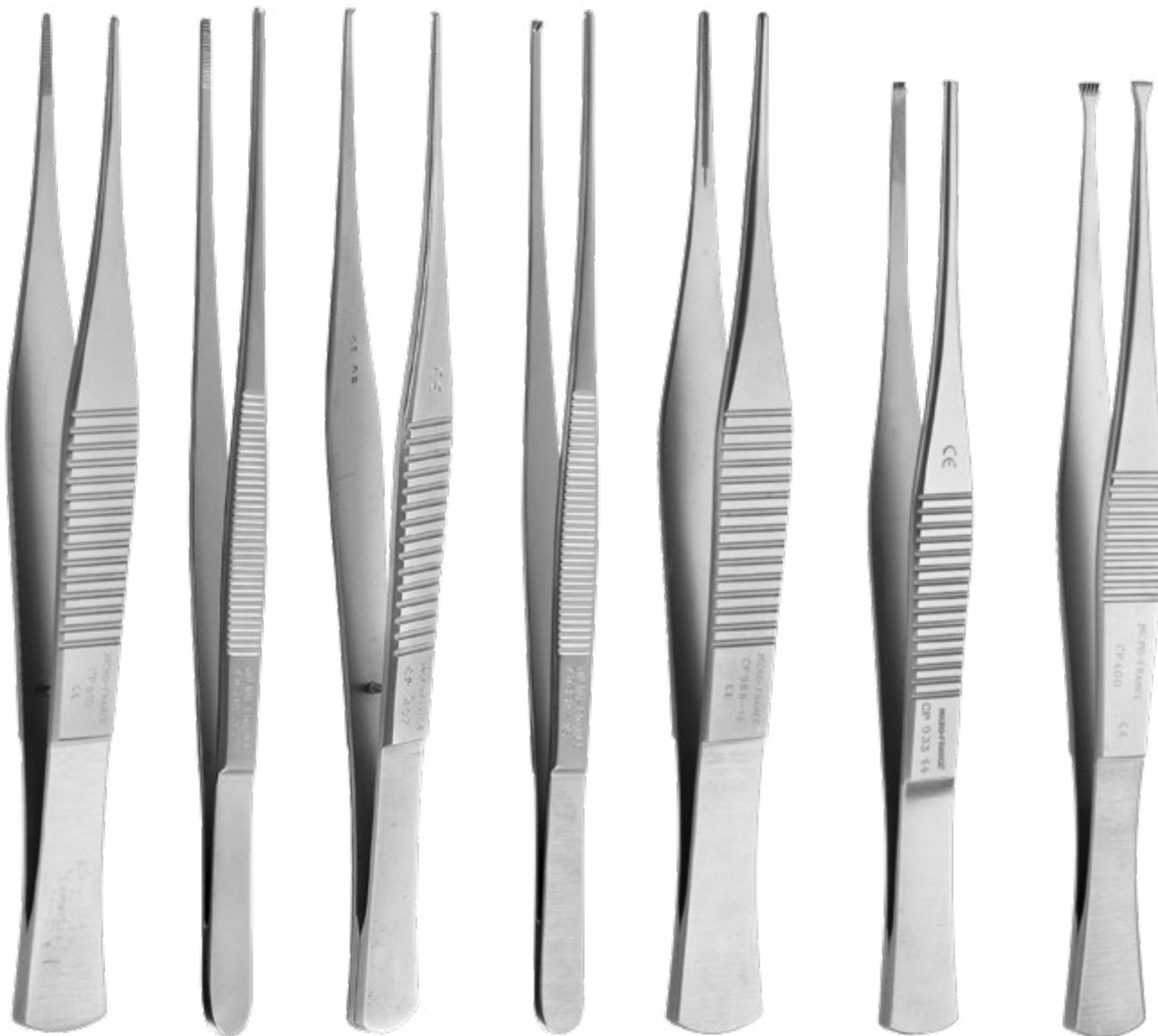

150mm

140mm

CP415	7831A-15	CP407	7833A-15	CP988-15	CP933-14	CP400
Serrated jaws 1mm	Serrated jaws 1.5mm	1x2 teeth jaws 1mm	1x2 teeth jaws 1.5mm	Serrated jaws 1.5mm	3x4 teeth and serrated platform	5x5 teeth

Précelle



150mm

CP345

serrated angled jaws

Barraya



160mm

CP933-16

3x4 teeth and
serrated platform

Claué



160mm

CP401

5x6 teeth

Mac-Indoe



170mm

CP936

1x2 teeth and
serrated platform

Debakey



1,5mm
7831A-18
serrated jaws



1,5mm
CP988-18
serrated jaws



1mm
CP409
1x2 teeth

Barraya



1,5mm

7833A-18

1x2 teeth



1,5mm

CP933-18

3x4 teeth and serrated platform



6x6 teeth

CP400-2

Debakey



200mm	210mm
7832	7834
1mm	1mm
serrated jaws	1x2 teeth

2mm
7831A-20
serrated
jaws

1,5mm
CP988-20
serrated
jaws

2mm
7833A-20
1x2 teeth

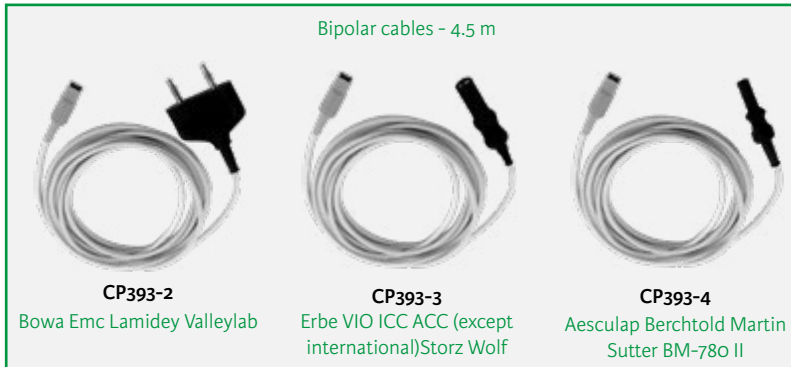

Magnan



Adson



110mm		120mm			160mm		200mm	
CP392-1R	CP604BR	CP605BR	CP392-2R	CP392-8R	CP392BI	CP392BS		
smooth jaws 1x8mm	serrated jaws 1.5mm	1x2 teeth 1.5mm	smooth jaws 1x8mm	smooth jaws 1x8mm	smooth jaws 0.5x5mm	smooth jaws 0.5x5mm		

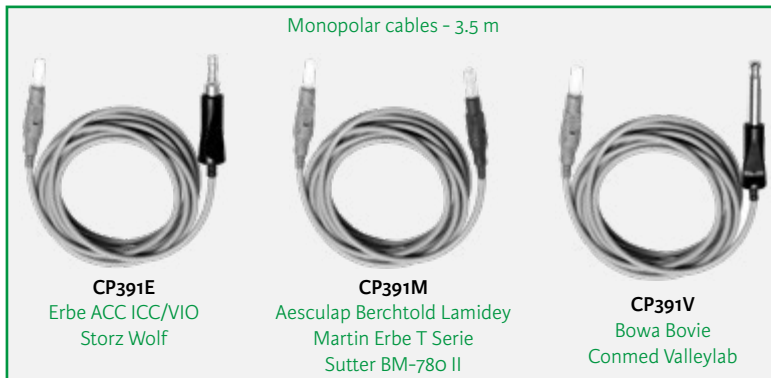

Adson



110mm

CP390-1

Smooth jaws
1x8mm



120mm

CP604M

Serrated jaws
1.5mm



CP605M

1x2 teeth
1.5mm



160mm

CP390-2

Smooth jaws
1x8mm



CP390-8

1x2 teeth
1x8mm

Halsey

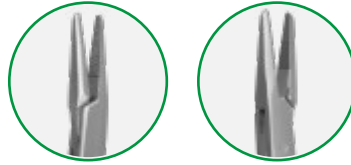

130mm

703T	704T
serrated jaws	Smooth jaws
for needle 4/0 5/0	



703T

Crile-Wood Mayo-Hégar

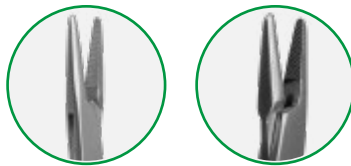

150mm

702T	714T
needle 4/0 5/0 6/0	1/0 2/0 3/0 4/0



702T

Becker



130mm

CP1107
Diamond jaws

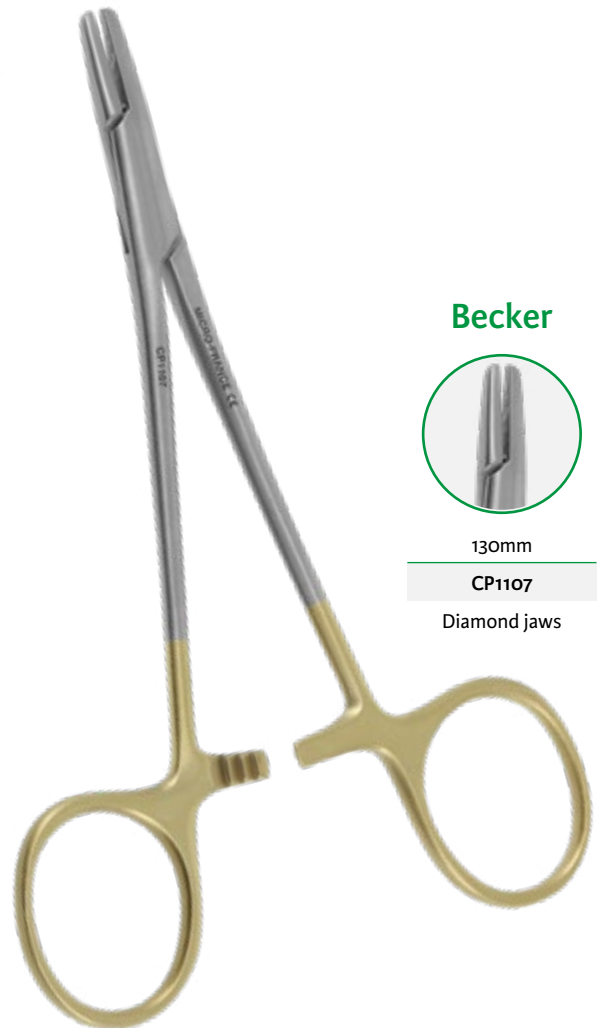



Leriche

140mm - without teeth

7867-1	7867-2
--------	--------

Straight	Curved
----------	--------

140mm - with teeth

7867-3	7867-4
--------	--------

Straight	Curved
----------	--------

7867-1

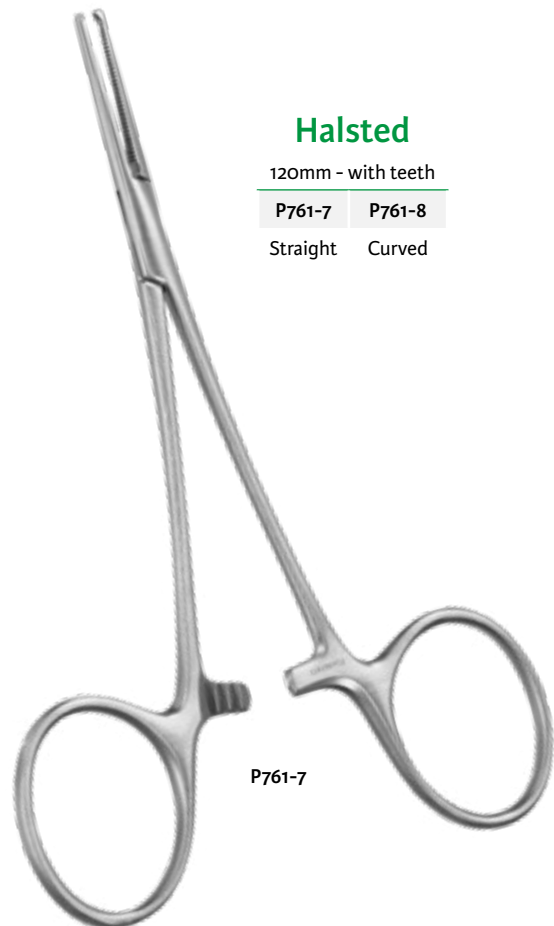

Halsted

120mm - with teeth

P761-7	P761-8
--------	--------

Straight	Curved
----------	--------

P761-7

Kelly

without teeth

140mm	160mm
P762-2	P762-4
Curved	Curved



P762-2

Kocher

140mm 160mm 180mm

Straight without teeth

P764-1	P764-5	-
--------	--------	---

Straight with teeth

P764-3	P764-7	P764-11
--------	--------	---------



P764-3

Martel

130mm

P763

Forceps with
teeth, 'T' tip



Péan

140mm 160mm

P765-14 P765-16

Haemostatic forceps
serrated jaws



Terrier

130mm

P769

Haemostatic forceps
serrated jaws



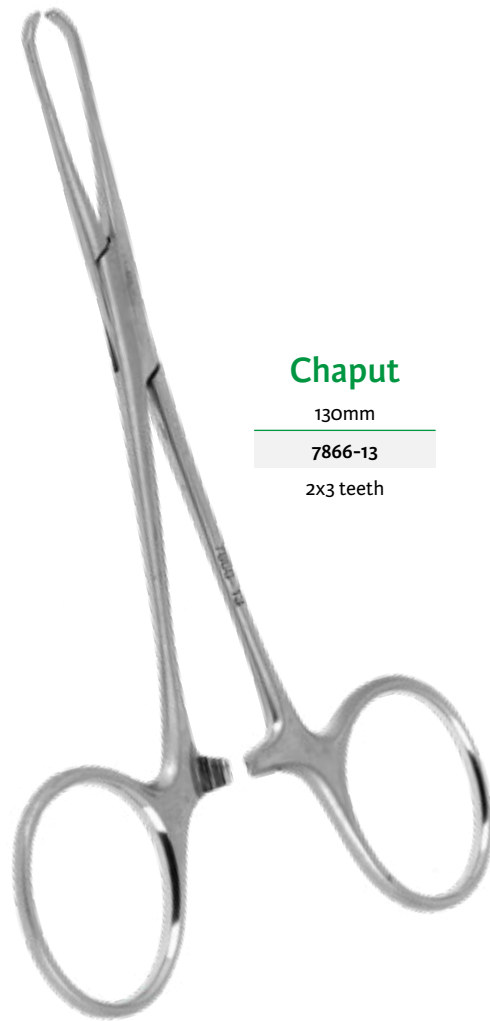

Chaput

130mm

7866-13

2x3 teeth

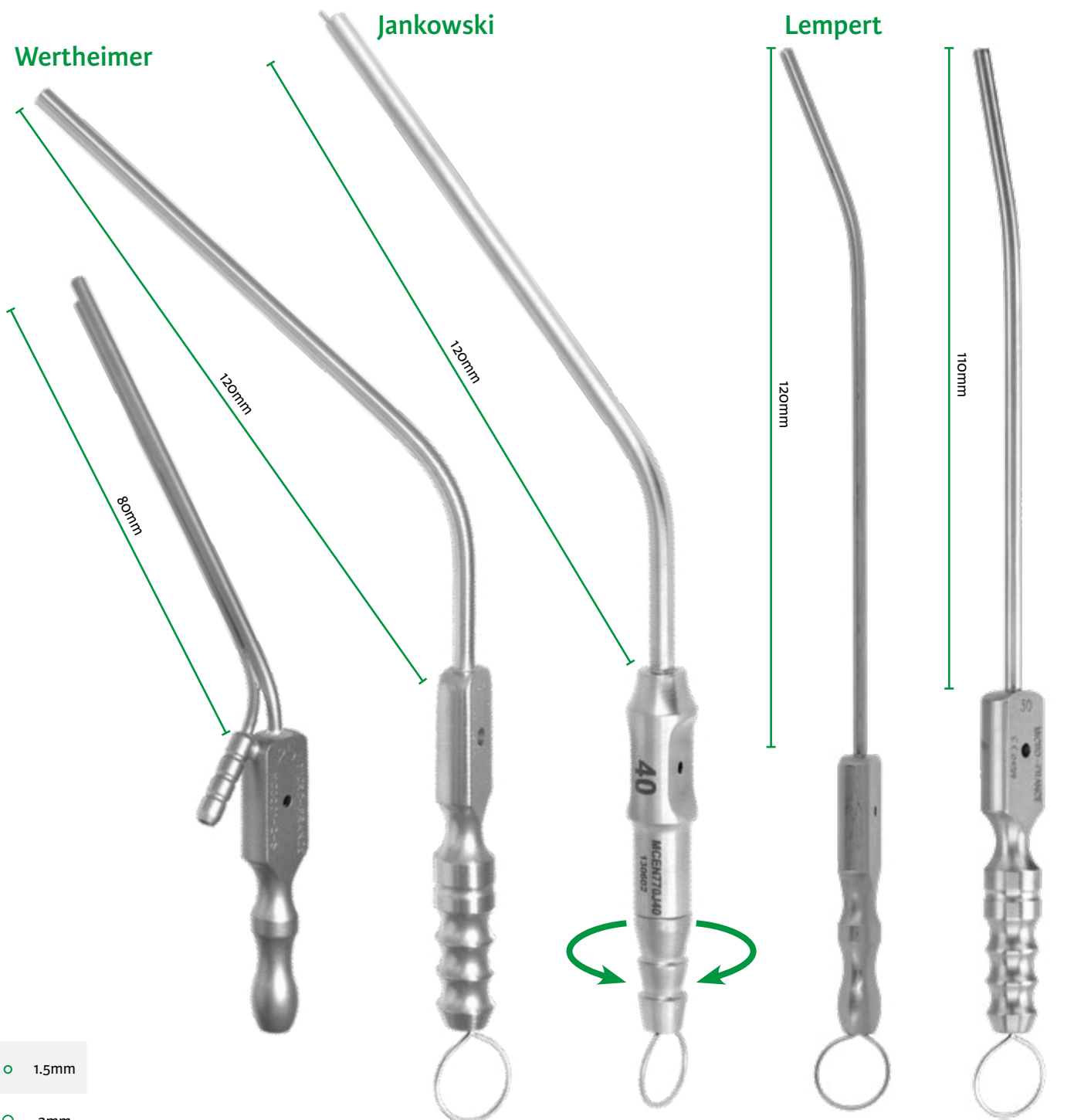

- 1.5mm
- 2mm
- 2.5mm
- 3mm
- 3.5mm
- 4mm

Wertheimer		Jankowski		Lempert			
MCO201-2-5	2.5mm	MCO770-1-5	1.5mm	MCEN770J40	4mm	MCO771-2-5	2.5mm
MCO201-3-0	3mm	MCO770-2-0	2mm	MCEN770J30	3mm	MCO771-3-0	3mm
		MCO770-2-5	2.5mm			MCO771-4-0	4mm
		MCO770-3-0	3mm				
		MCO770-3-5	3.5mm				
		MCO770-4-0	4mm				
						CP330-3-0	3mm
						CP330-4-0	4mm

Luer-lock adapter

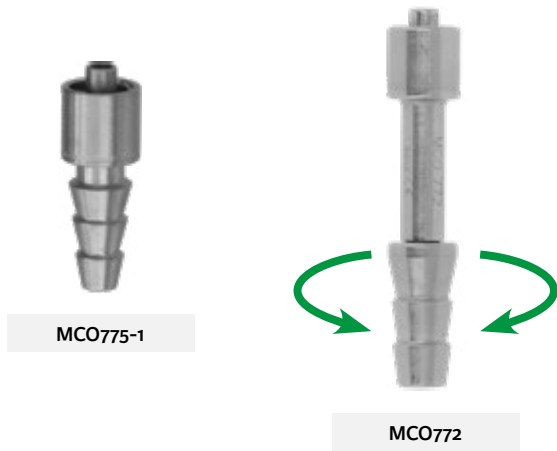

Suction tube adapter with finger control

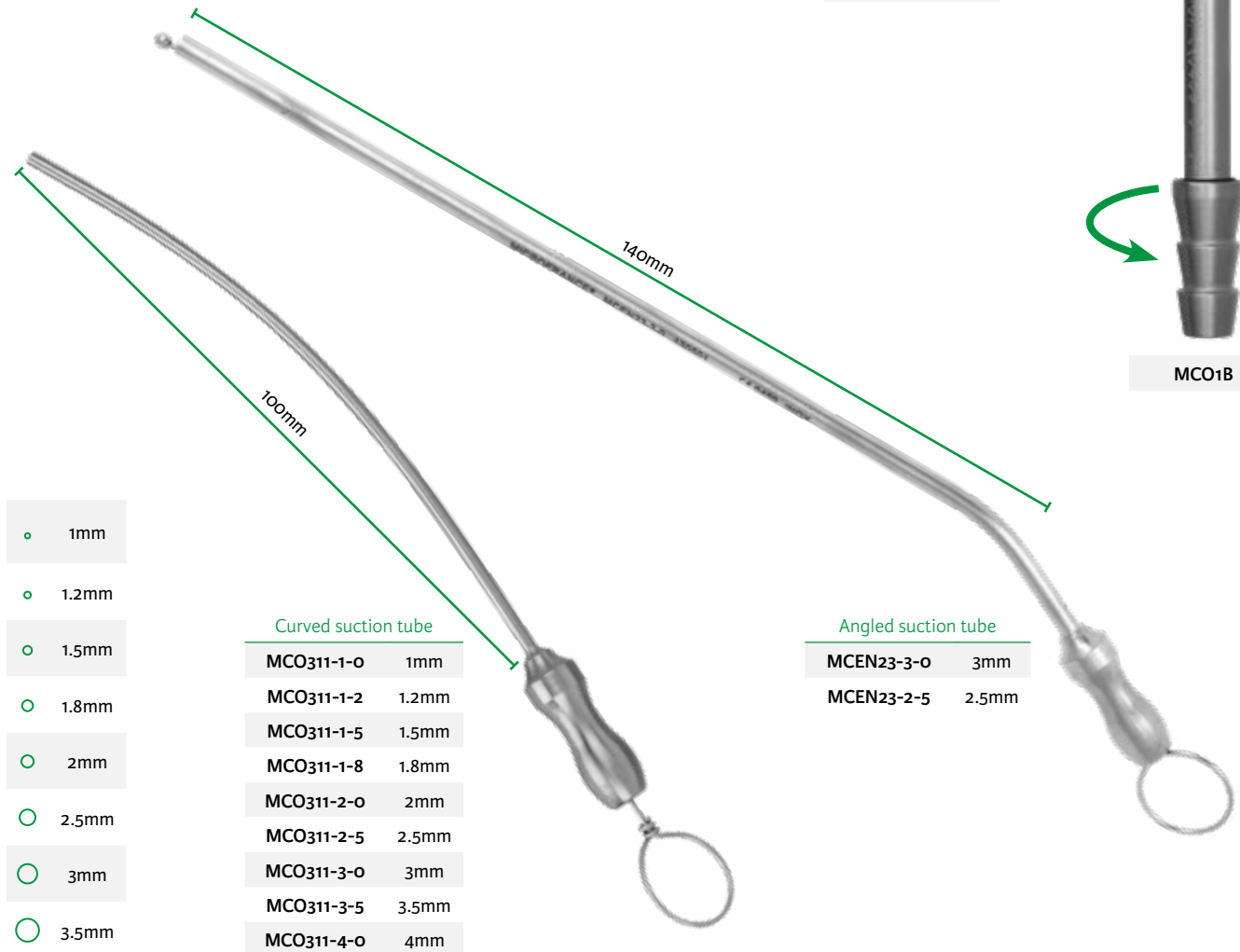
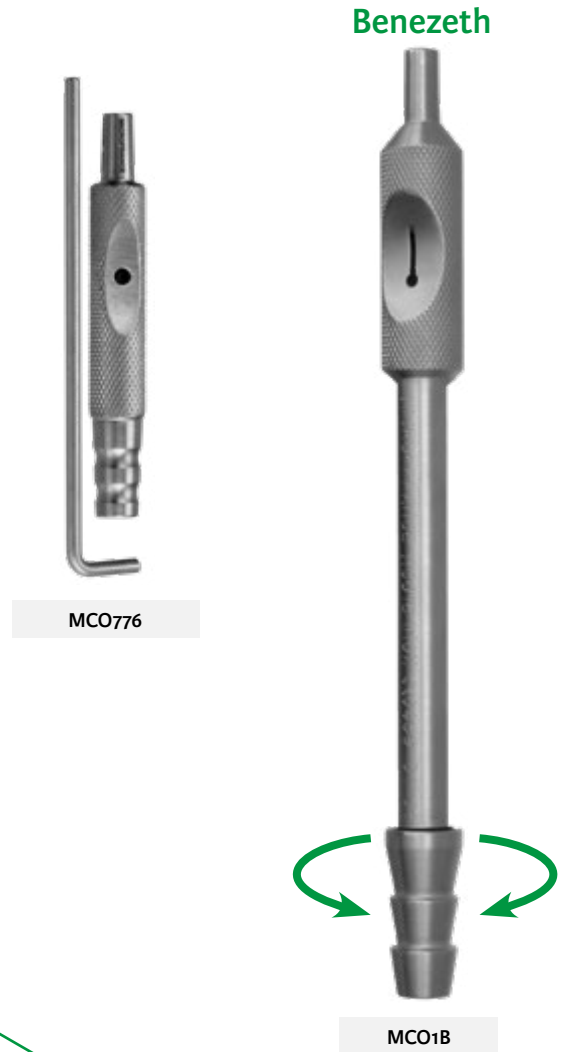

- 1mm
- 1.2mm
- 1.5mm
- 1.8mm
- 2mm
- 2.5mm
- 3mm
- 3.5mm
- 4mm

Curved suction tube

MCO311-1-0	1mm
MCO311-1-2	1.2mm
MCO311-1-5	1.5mm
MCO311-1-8	1.8mm
MCO311-2-0	2mm
MCO311-2-5	2.5mm
MCO311-3-0	3mm
MCO311-3-5	3.5mm
MCO311-4-0	4mm

Angled suction tube

MCEN23-3-0	3mm
MCEN23-2-5	2.5mm

110mm

MCEN37-1-20	2mm
MCEN37-1-25	2.5mm
MCEN37-1-30	3mm
MCEN371D35	3.5mm
MCEN371D4	4mm

Malleable

MCEN37-2-0	2mm
MCEN37-2-5	2.5mm
MCEN37-3-0	3mm
MCEN37-3-5	3.5mm
MCEN37D4	4mm

De Gabory

Handle for suction tube
rotatable connection

MCEN103LDG

Scale 2/3

MCEN103LDG

On - Off

120mm

Blunt suction tube
with finger control

MCEN770B25	2.5mm
MCEN770B30	3mm



MCEN77-3-0	3mm
MCEN77-3-5	3.5mm

Jankowski

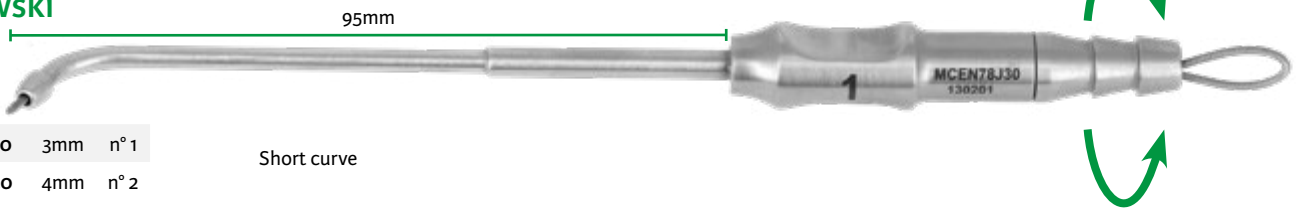

MCEN78J30	3mm	n° 1
MCEN78J40	4mm	n° 2

Short curve

Jankowski

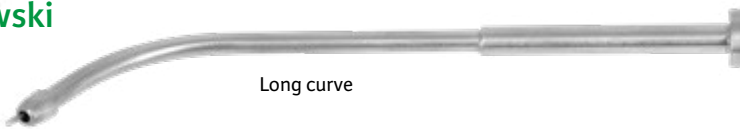

Long curve

MCEN79J25	2.5mm	n° 3
MCEN79J30	3mm	n° 4
MCEN79J40	4mm	n° 5

Orsel

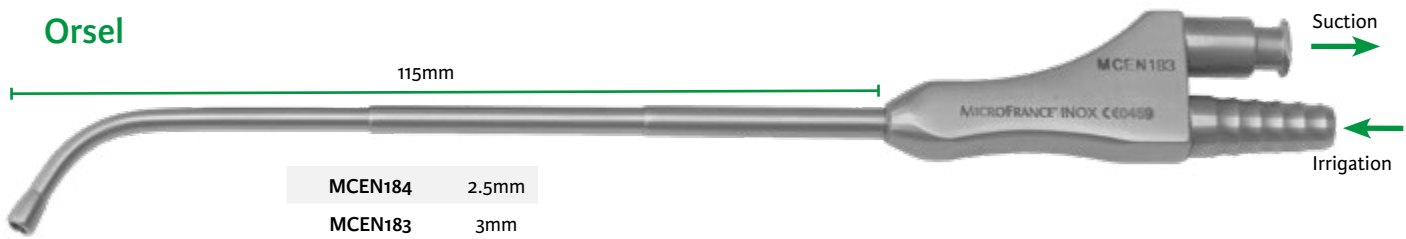

MCEN184	2.5mm
MCEN183	3mm

Orsel

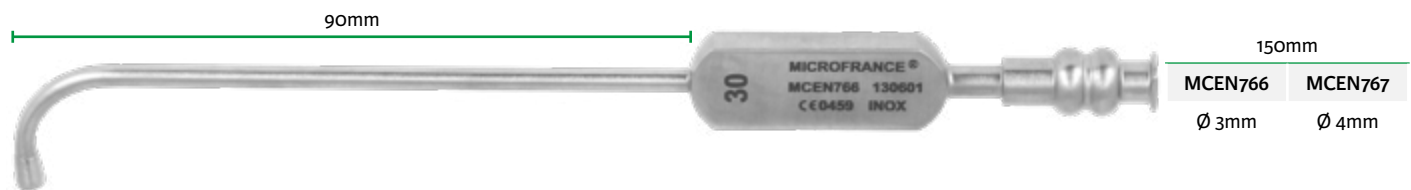

	150mm	
MCEN766	MCEN767	
Ø 3mm	Ø 4mm	

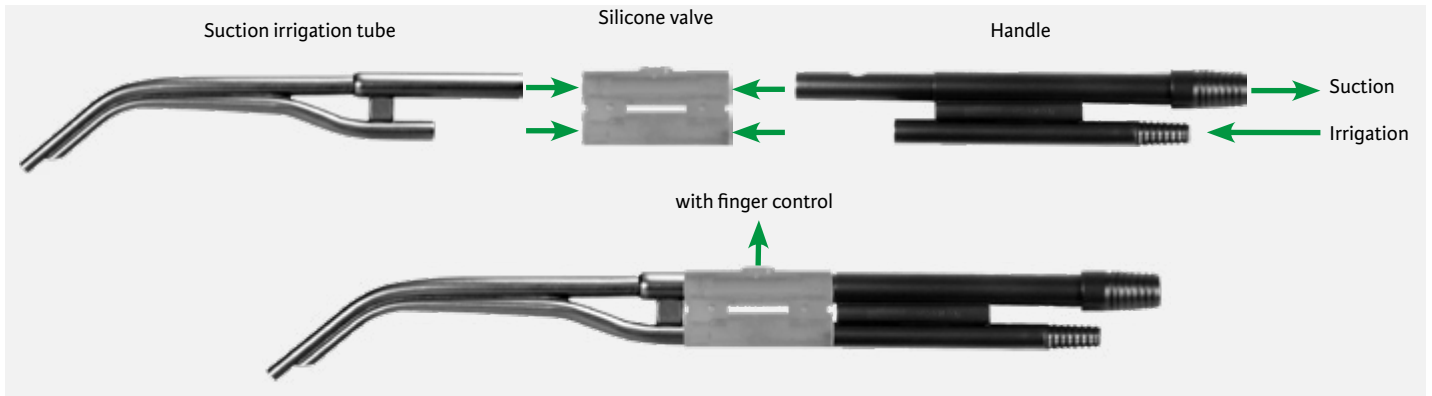

Handle
Delivered with silicone valve

1375012



Suction irrigation tube without hole

Reference	Working length	Size fr	Size mm
1375020	100mm	10X10	3.3 X 3.3



Suction irrigation tube with hole

Reference	Working length	Size fr	Size mm
1375025	100mm	10X10	3.3 X 3.3



1375025

1375101 90mm 5X4 1.7 X 1.4

1375102 90mm 4X4 1.4 X 1.4

1375103 90mm 4X3 1.4 X 1

1375107 90mm 7X7 2.3 X 2.3

1375110 90mm 10X7 3.3 X 2.3

1375114 90mm 14X7 4.7 X 2.3

1375201 120mm 5X4 1.7 X 1.4

1375207 120mm 7X7 2.3 X 2.3

1375210 120mm 10X7 3.3 X 2.3

1375214 120mm 14X14 4.7 X 4.7



1375101



1375107

Dessi pump accessories



irrigation tubing Sterile,
disposable
single use

MCEN84S^(D)

Pack 20

Used with irrigation pump
MCEN80

Scale 2/3

- 0° MCEN83-C
- 30° MCEN81-C
- 45° MCEN87C
- 70° MCEN82-C

MCEN82-C
L 150mm

Cleaning instrument

Working length "L"

Comeg



MCEN81O
L 140mm

Olympus



L 140mm

L 125mm

	L 140mm	L 125mm			
0°	MCEN83O	MCEN83OL	for scope (WA96200A)	-	-
30°	MCEN81O	MCEN81O1	(WA96201A)	MCEN81O2	for scope (WA96202A)
45°	-	MCEN87O3	(WA96203A)	MCEN87O4	(WA96204A)
70°	MCEN82O	MCEN82O5	(WA96205A)	MCEN82O6	(WA96206A)

- 0° MCEN83-S
- 30° MCEN81-S
- 45° MCEN87-S
- 70° MCEN82-S

MCEN83-S
L 150mm

Storz



- 0° MCEN83-W
- 25° MCEN81-W
- 30° MCEN81-W
- 45° MCEN87W
- 70° MCEN82-W

MCEN83-W
L 150mm

Wolf



MCEN88SC
L 150mm

Sopro Comeg



Sleeve for variable scope

MCEN88SC

for scope : pattern :
Olympus WA9T400V
Sopro Comeg Ulyss

^(D) Distributed by Integra MicroFrance SAS (France) - For corresponding manufacturer part numbers, see table in annex

Scale 2/3

Trocar and cannula

Working length "L"

Rouvier

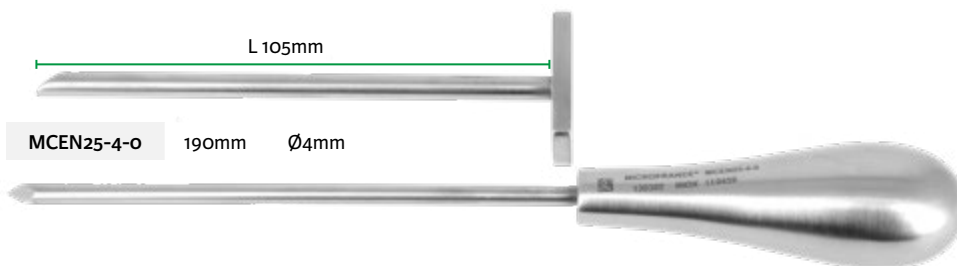

Biopsy cup forceps for trocar MCEN25-4-0

MCEN28

Double-action jaws
2x5mm

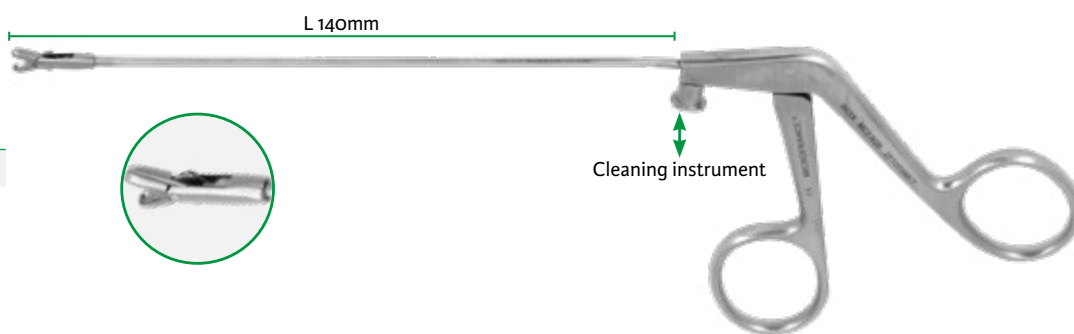

Albertini

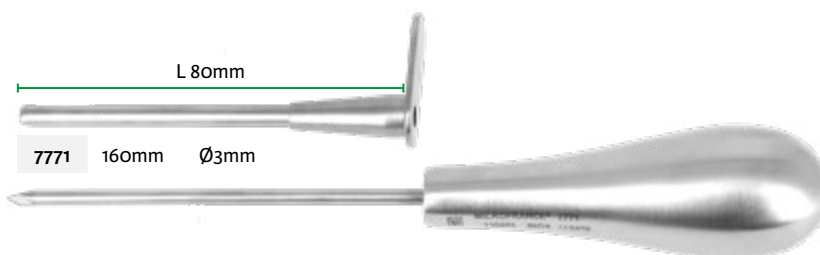

Irrigation tube

Albertini

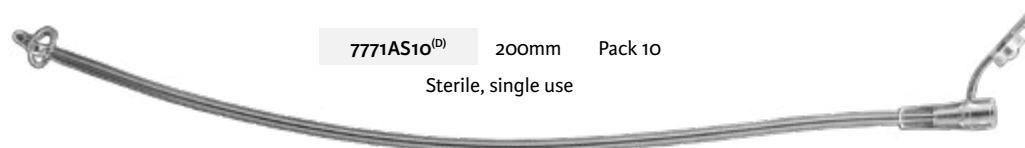

Irrigation tube guide

Albertini

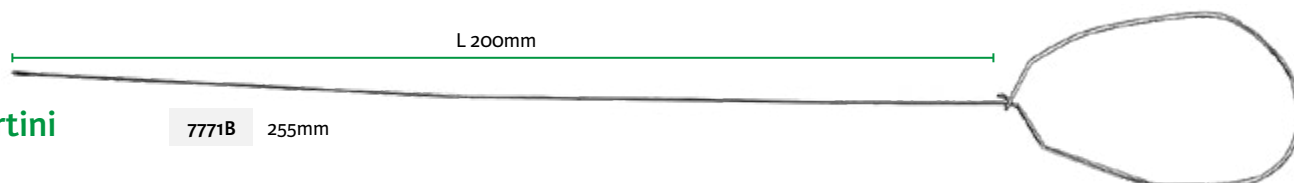

⁽¹⁾ Distributed by Integra MicroFrance SAS (France) - For corresponding manufacturer part numbers, see table in annex

Pradès

220mm

MCEN55

7,5mm



Gillies

230mm

3714379

7mm

Seeker



190mm

MCEN713

ball
Ø 2,3mm

Pick

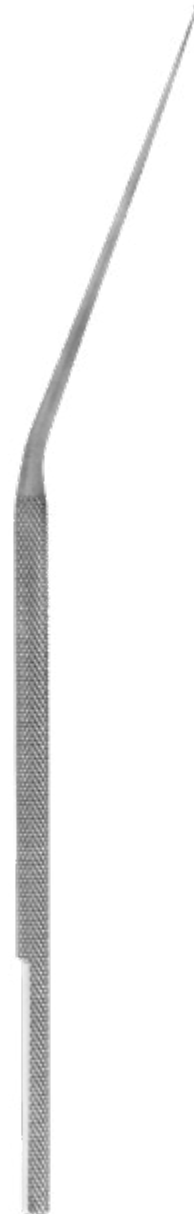

160mm

1352431

Ø 0,6mm
"Mushroom" pick

Herman

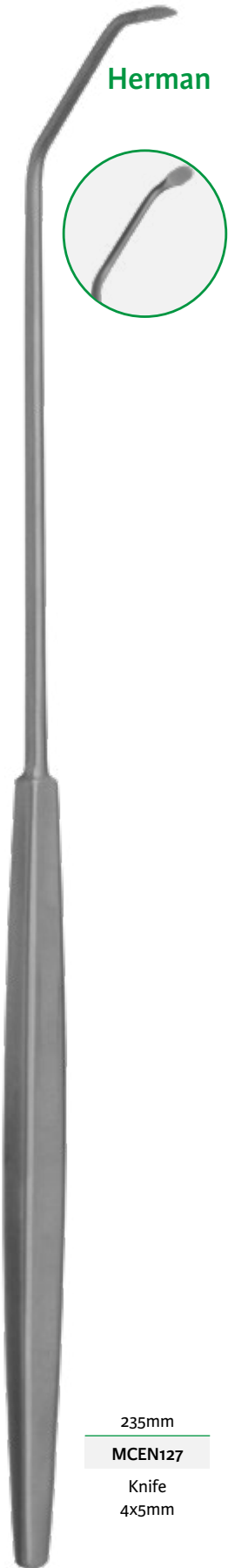

235mm
MCEN127
Knife
4x5mm

Friedrich



180mm
MCEN44
Sickle knife
9mm

Rouvier



180mm
MCEN50
Dissector
and knife

Lérault



190mm
MCEN103
Angled
elevator
and knife
3mm

Scale 2/3

L 110mm

Working length "L"

Fenestrated cup jaws



MCEN33	MCEN34
3x6mm	3x6mm

Fenestrated cup jaws



MCEN90	MCEN91	MCEN91B
3x7mm	3x7mm	3x10mm

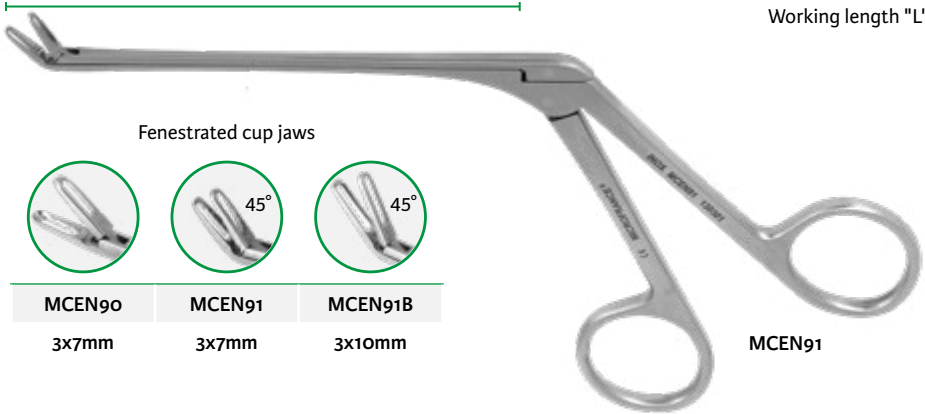

MCEN91

Blakesley-Klossek

Fenestrated cup jaws, 3mm



MCEN56	MCEN56-1
à droite	à gauche

Klossek

L 110mm

Suction

Thru-flow suction



7762-5	3mm
--------	-----

Thru-flow suction



7762A-5	3mm
---------	-----

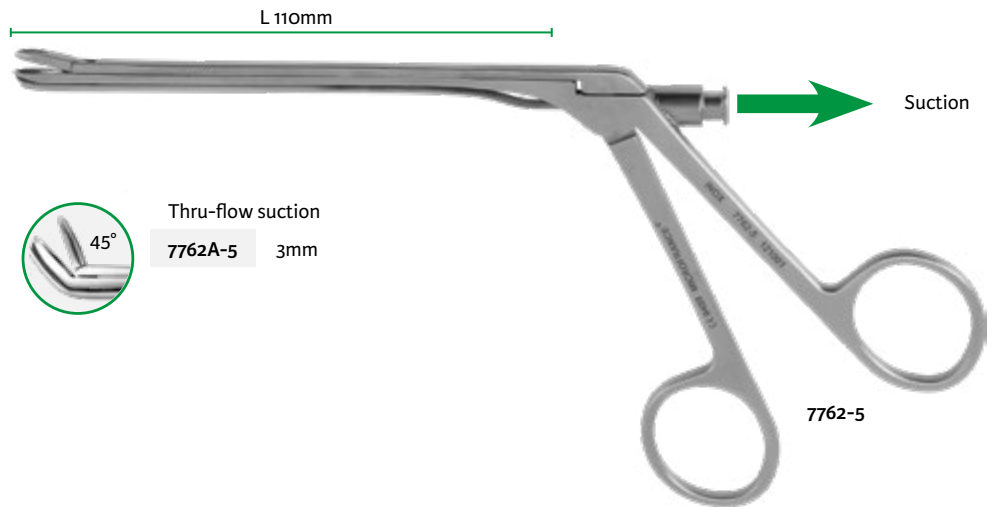

7762-5

Dessi

L 125mm

Cleaning instrument

0°



45°



90°





MCEN61
3mm

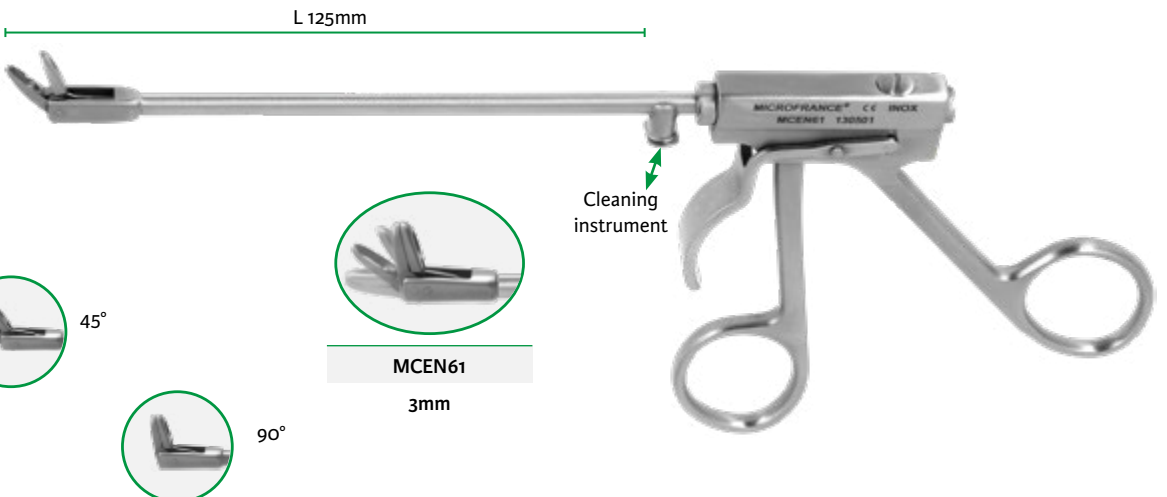

MCEN61

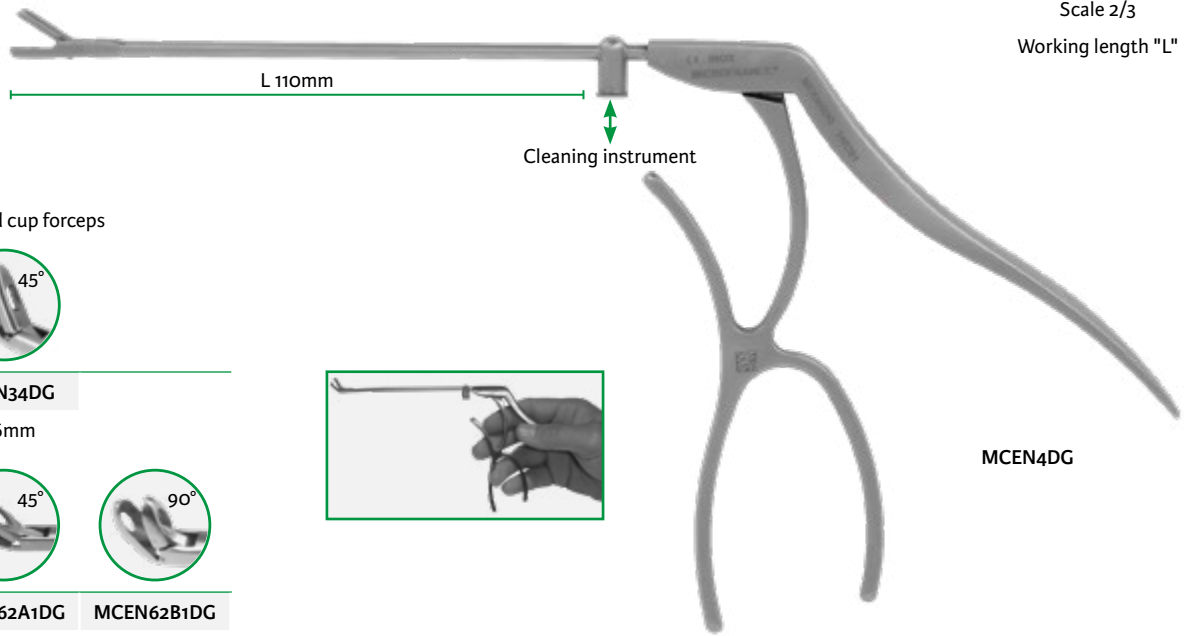

Fenestrated cup forceps



MCEN33DG
3x6mm



MCEN34DG
3x6mm



MCEN62T1DG
3x8mm



MCEN62A1DG
3x8mm



MCEN62B1DG
3x8mm



MCEN62T2DG
5x11mm



MCEN62A2DG
5x11mm

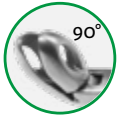

MCEN62B2DG
5x11mm



Fenestrated cup forceps



MCEN90DG
3x7mm



MCEN91DG
3x7mm



MCEN91BDG
3x10mm

Cup forceps



MCEN4DG
3x6mm



MCEN5DG
3x6mm

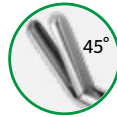

MCEN5BDG
3x12mm

Stylet handle for curette insert

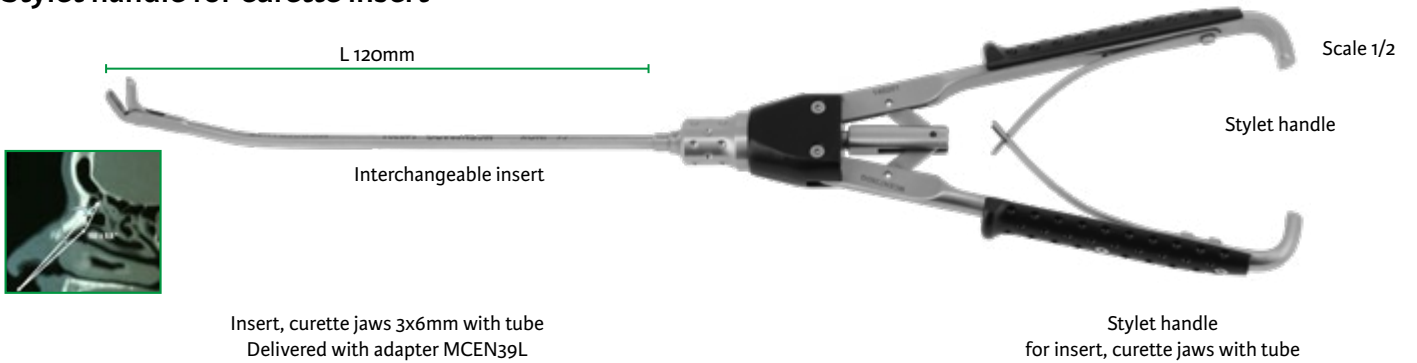

MCEN68CDG
Straight tube



MCEN68BDG
Angled tube



MCEN68ADG
Insert 45°
angled tube



MCEN39L
Adapter luer-lock for tube insert cleaning port - Pack 3

Scale 1/2

Scale 1/4

MCEN728DG

Scale 2/3

Working length "L"

Fenestrated cup forceps

Straight 45° 90°



jaws 3x8mm

MCEN62T1 MCEN62A1 MCEN62B1



jaws 5x11mm

MCEN62T2 MCEN62A2 MCEN62B2



jaws 6x11mm

MCEN62T3 MCEN62A3 MCEN62B3



jaws 4x17mm

7762A4



MCEN62A2

Cup forceps, curved up



Curve	Horizontal opening	Vertical opening
70°	MCEN350H	MCEN350V
100°	MCEN360H	MCEN360V

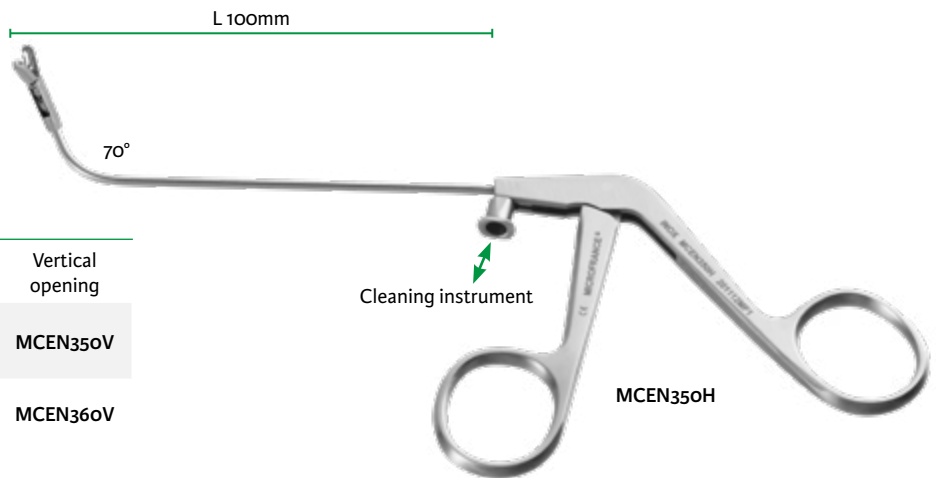

MCEN350H

Cleaning instrument

L 90mm

Cup forceps, curved up, pear jaws



MCEN960H

curve 80°

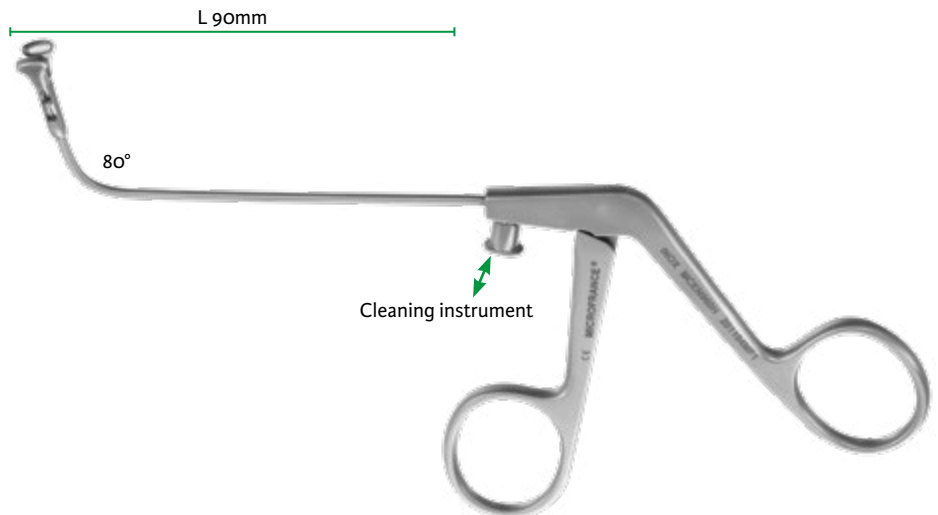

Cleaning instrument

Rouvier



MCEN4
3x6mm



MCEN5
3x6mm

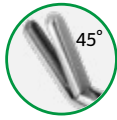

MCEN5B
3x12mm



MCEN43
1x4mm
30°



MCEN3
2mm

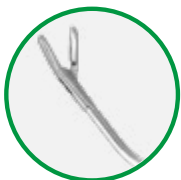

MCEN29
2x5mm
45°
right vertical opening

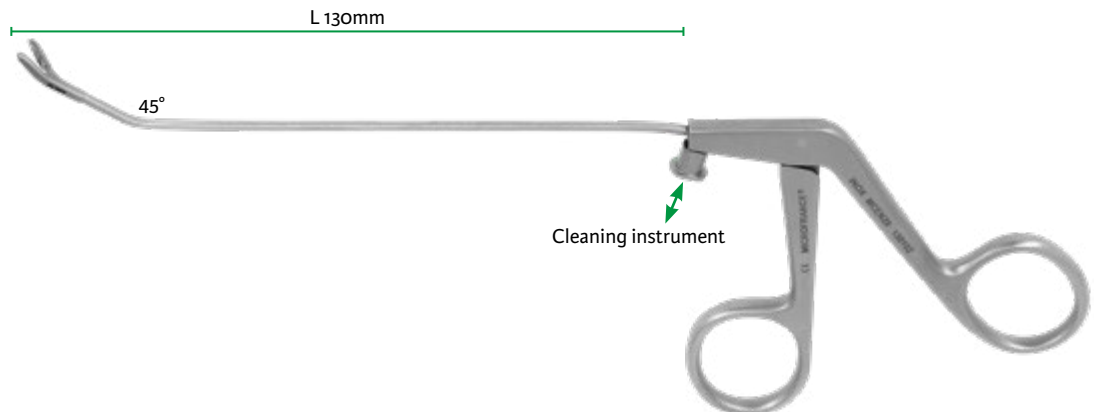
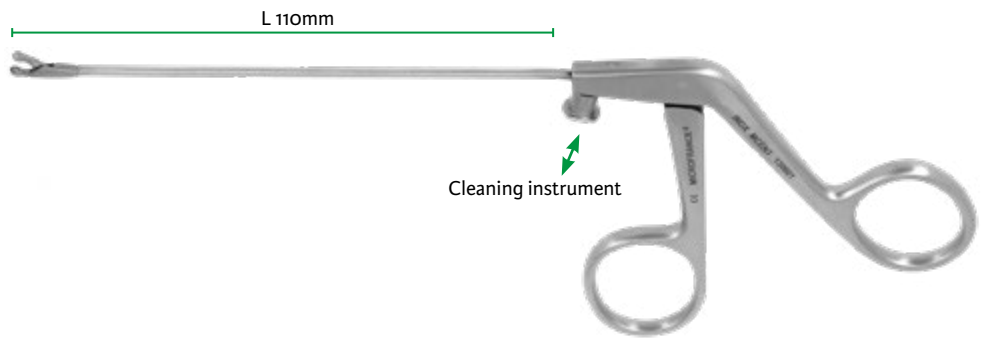

Fenestrated cup forceps

Weil-Blakesley

Blakesley

Straight

45°

90°



7762-1

7762A-1

7762B-1

Jaws 3mm

Weil-Blakesley



7762-2

7762A-2

3.5mm jaws



Scale 2/3

Working length "L"

Fenestrated cup forceps
Jaws 2mm

straight 45°

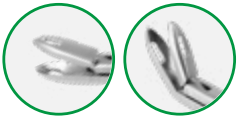

7763

7763-1

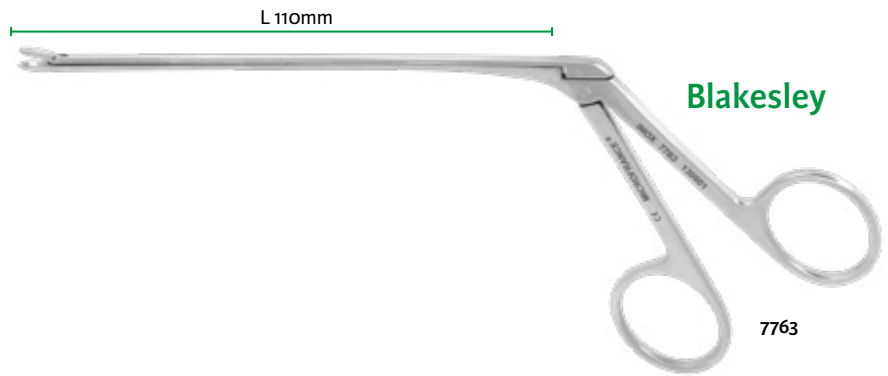

Blakesley

7763

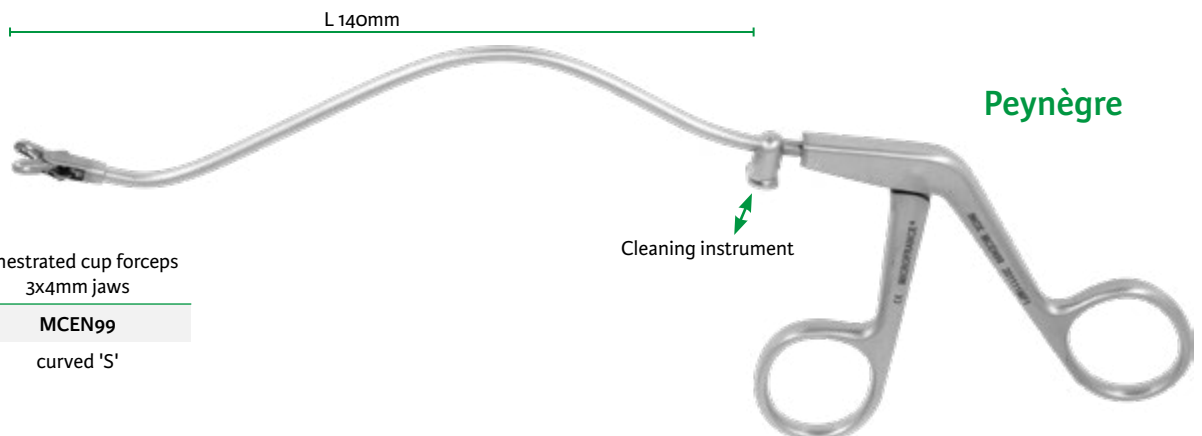
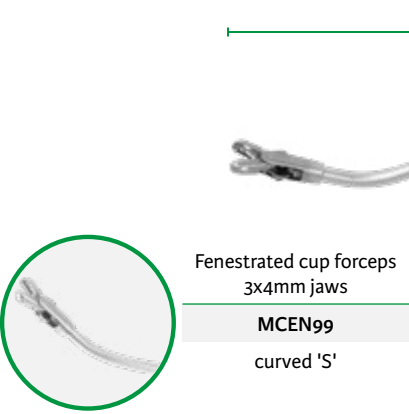
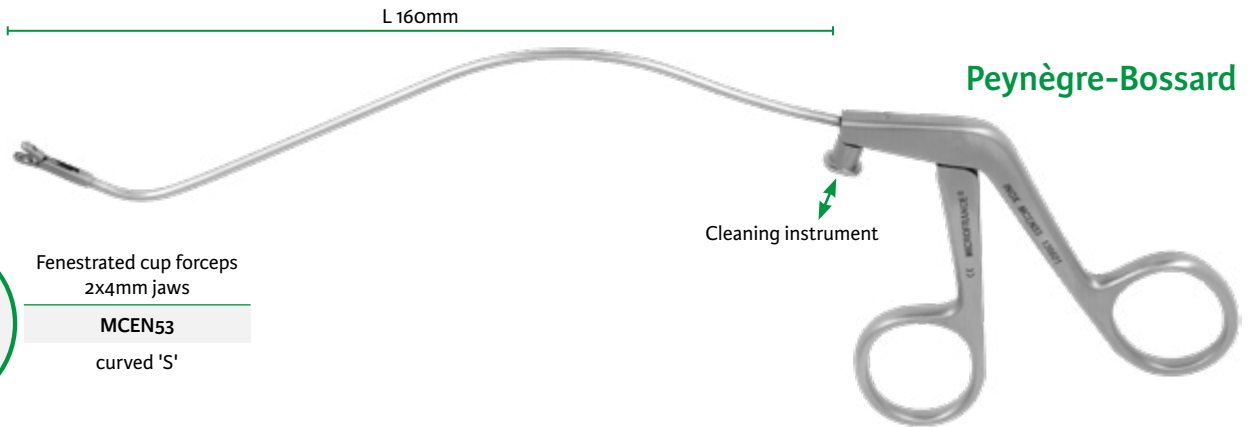
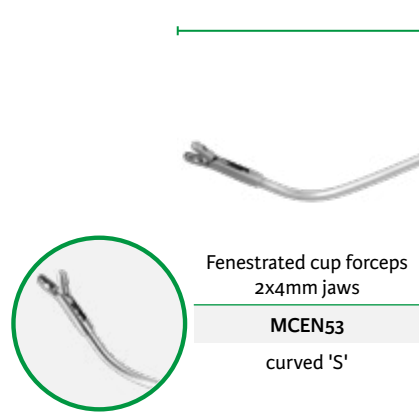
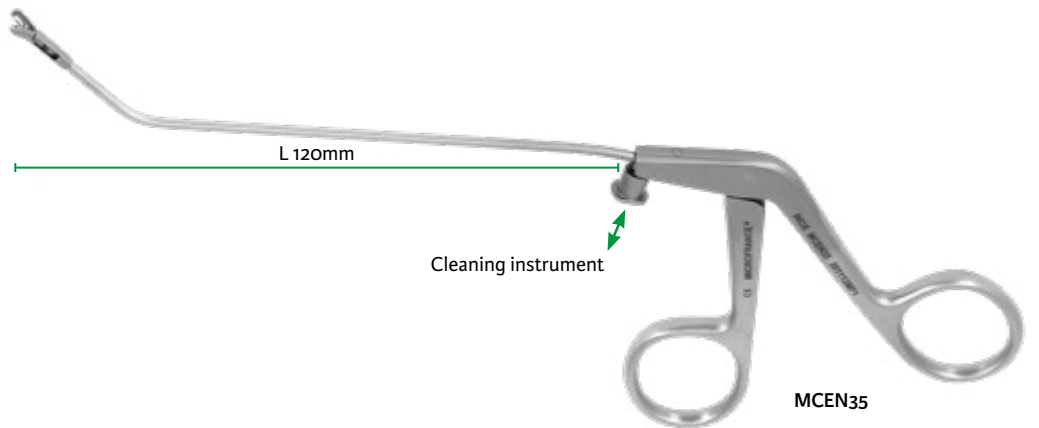
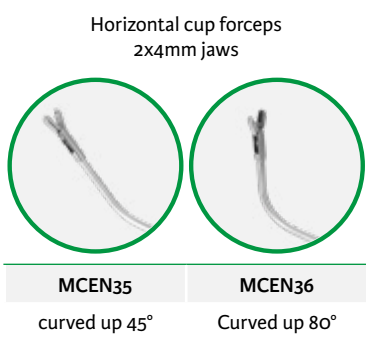
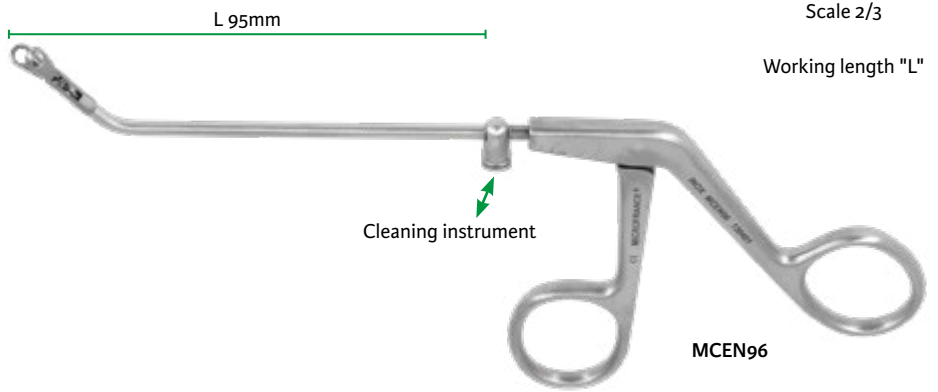
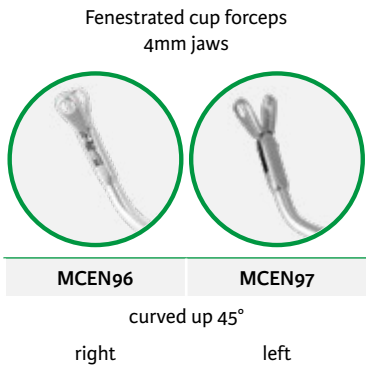

Scale 2/3

Working length "L"

Orsel



3x4.5mm Jaws

MCEN68

Curved down 130°

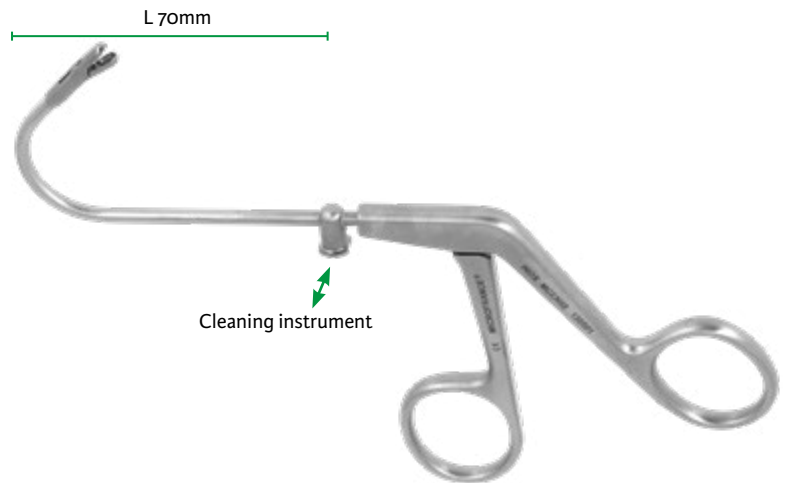

Terrier

curved down

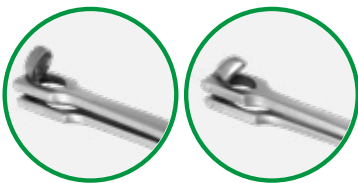

MCEN27-1

3x6mm jaws
L 100mm

MCEN27

4x7mm jaws
L 120mm

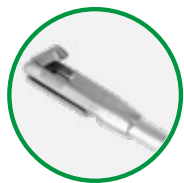
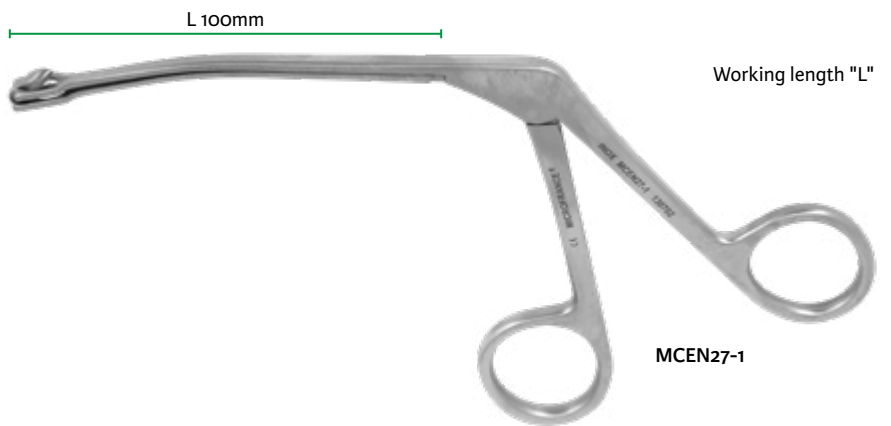

rotatable 360°

MCEN27R

2.5x7mm jaws

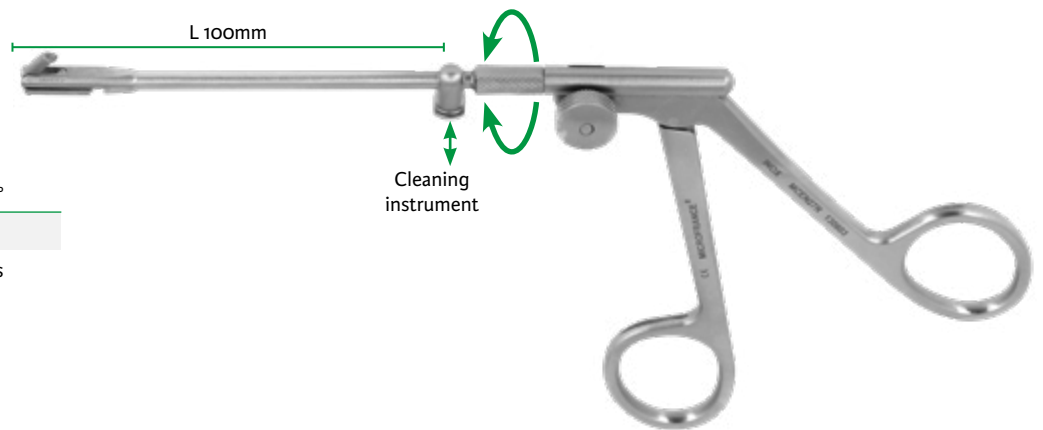

Terrier

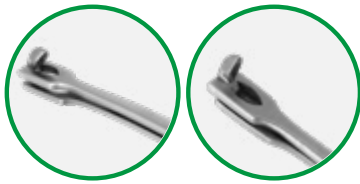

Jaws 2x4mm

MCEN27-2	MCEN27-3
curved down	curved up

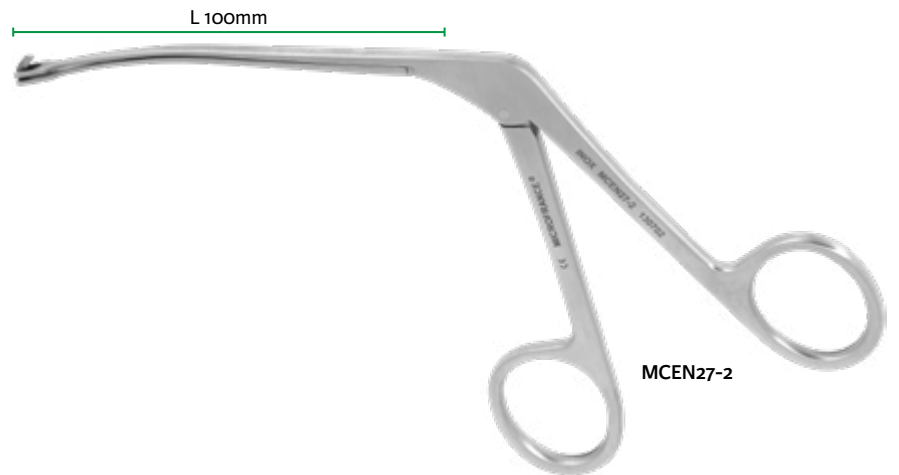

Terrier



Working length "L"



Punch cutting forceps
"Joséphine"
MCEN38
left opening

Rouvier

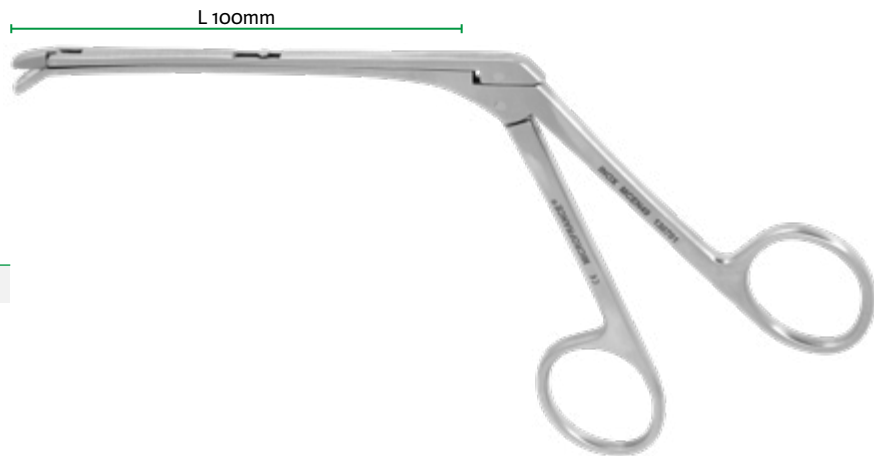

Backbiting punch
down 30°
MCEN49
jaws 4mm

Scale 2/3

Working length "L"

Struycken

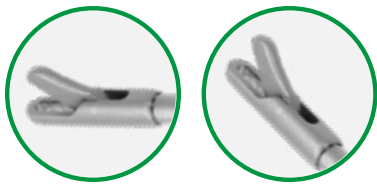

MCEN65	MCEN66
1,5mm straight	1,5mm up 45°

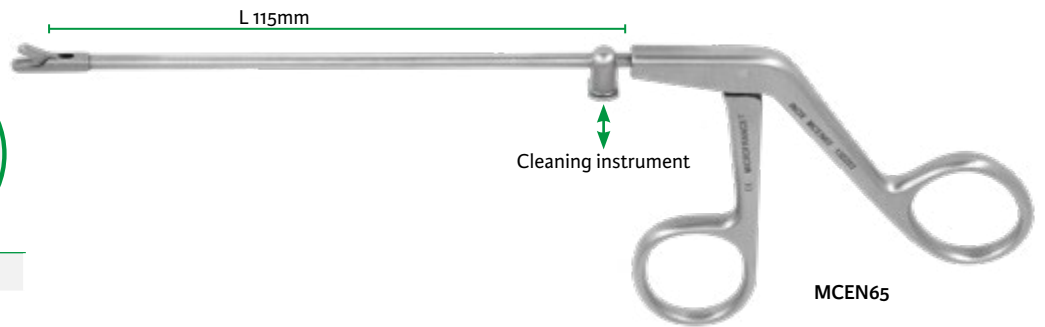

Struycken

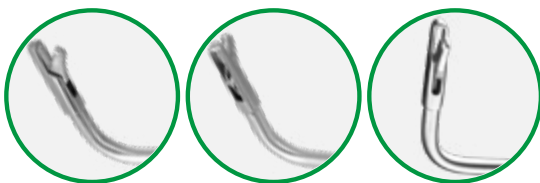

L 115mm		
MCEN67	MCEN67-1	MCEN67-2
1,5mm	right opening	left opening



Citelli-Peynègre

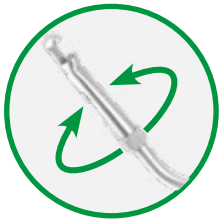

MCE98

3mm

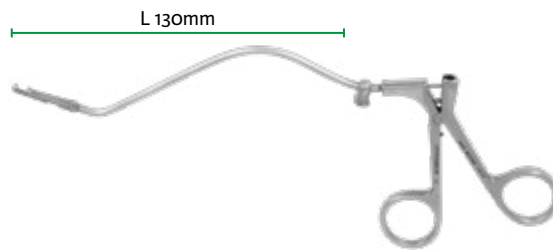

Working length "L"

Citelli-Frèche



MCE12

4mm - 45°

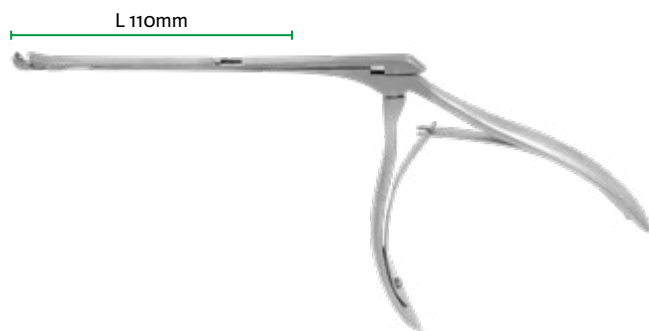

Scale 1/2

Jankowski

Titanium serrated blades 15mm



MCEN41J

Straight

MCEN42J

Curved left

MCEN42J1

Curved right

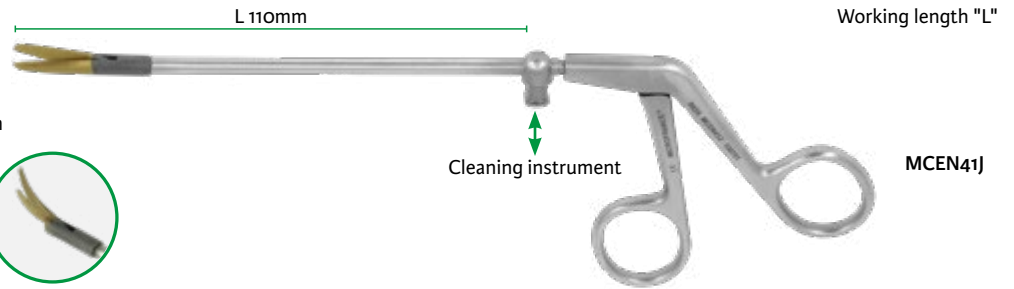

Working length "L"

MCEN41J

Dessi

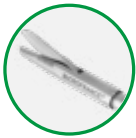

MCEN41D3

Serrated blades 10mm

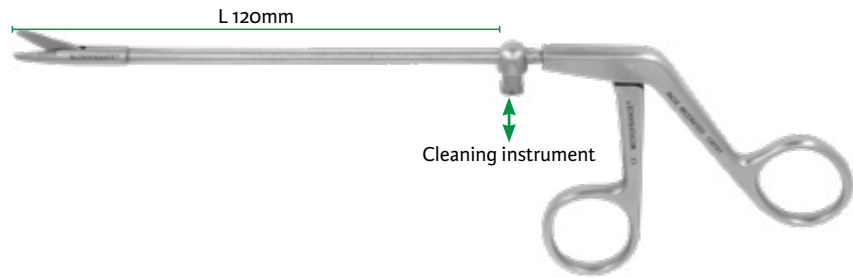

Peynègre



Serrated blades 10mm

MCEN41-1

Straight

MCEN42

Curved left

MCEN42-1

Curved right

Rouvier

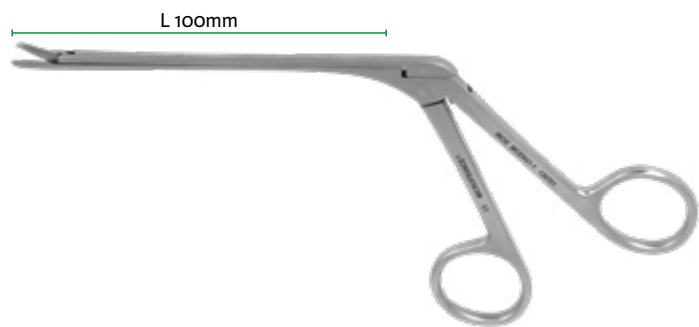

MCEN41-1

Scale 1/2

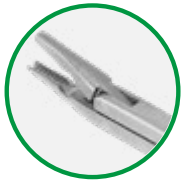

MCEN21
Clip LT200

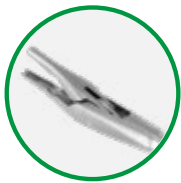
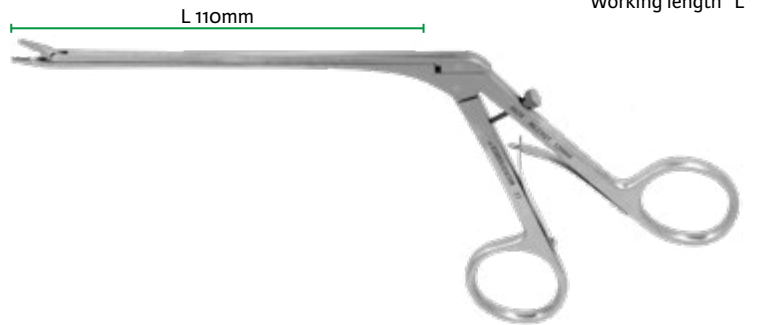

MCEN21R
Clip LT200

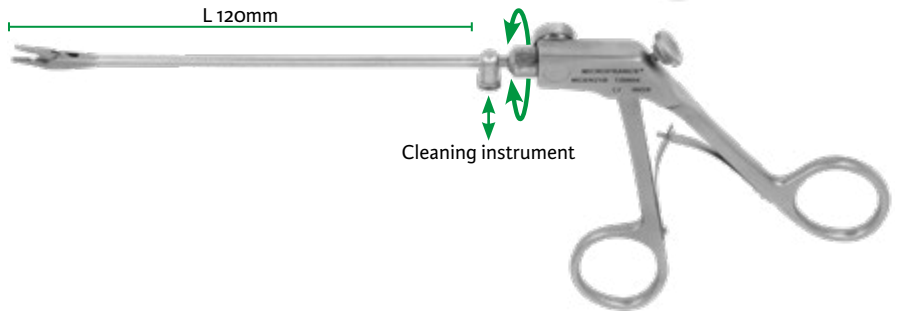

Wormald



MCEN211
Clip LT200

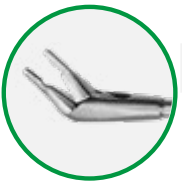

MCEN211S
Clip LT100

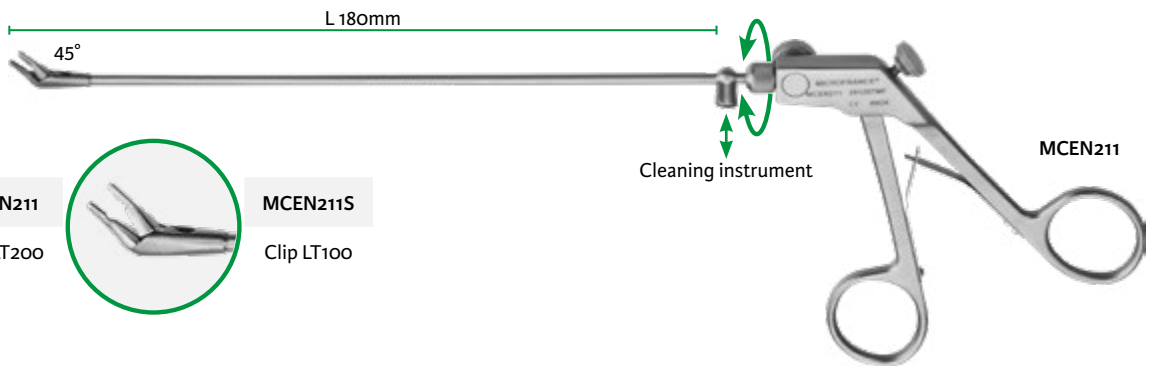

Wormald

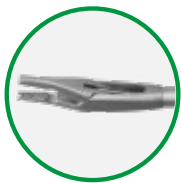

MCEN212
Clip LT200

MCEN212S
Clip LT100

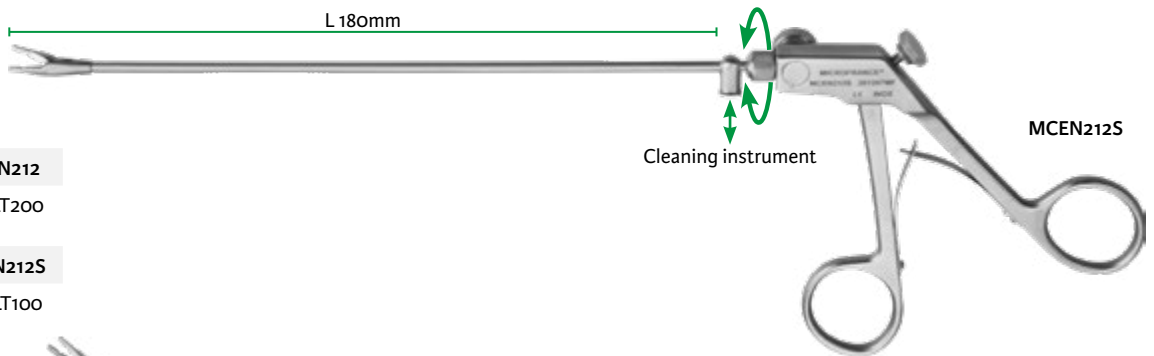

Wormald

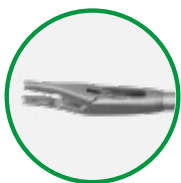

MCEN213
Clip LT200

MCEN213S
Clip LT100

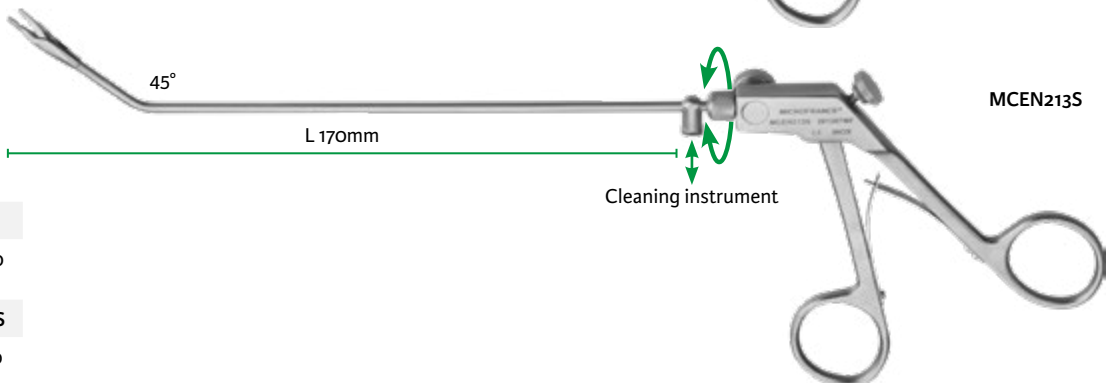

Bipolar forceps, 1 piece instrument

Scale 2/3

Working length "L"

Dessi

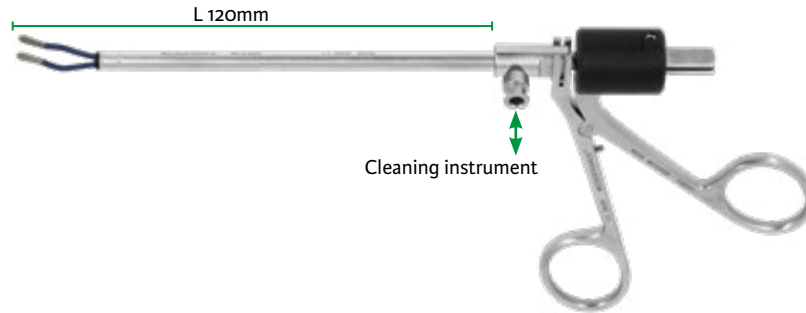

MCEN54

Bipolar forceps, 3-piece instrument

Dessi

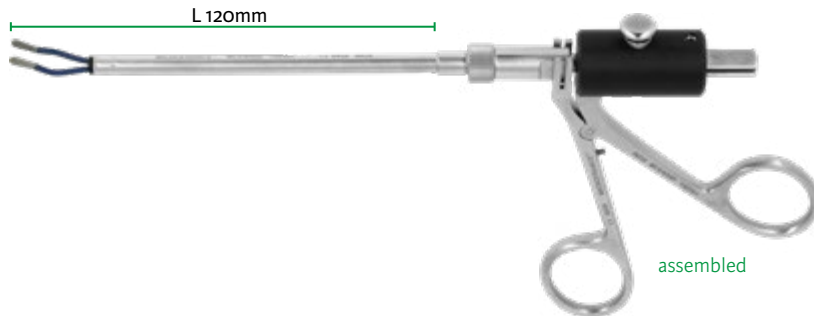

assembled

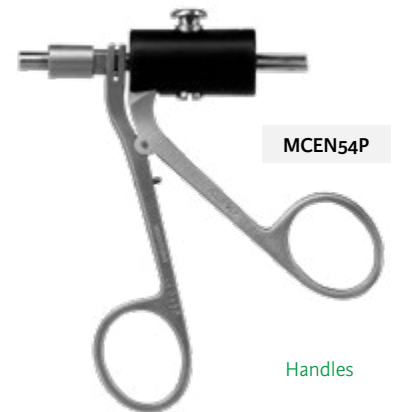

MCEN54P

Handles

MCEN54G



Tube

MCEN54I



Insert

MCEN54H



Herman
Insert



CEV669BG

Bipolar cables - 4,5 m

- CP393-2**
Bowa Emc Lamidey Valleylab
- CP393-3**
Erbe VIO ICC ACC (except international) Storz Wolf
- CP393-4**
Aesculap Berchtold Martin
Sutter BM-780 II

Scale 1/2

Working length "L"

Wormald

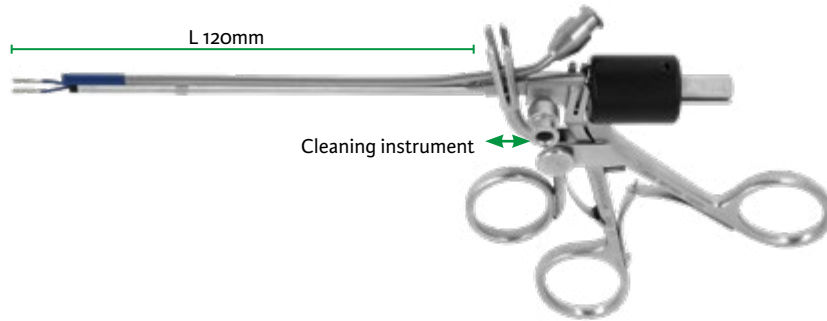
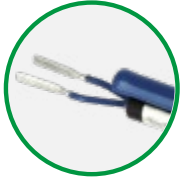

MCEN64

Wormald

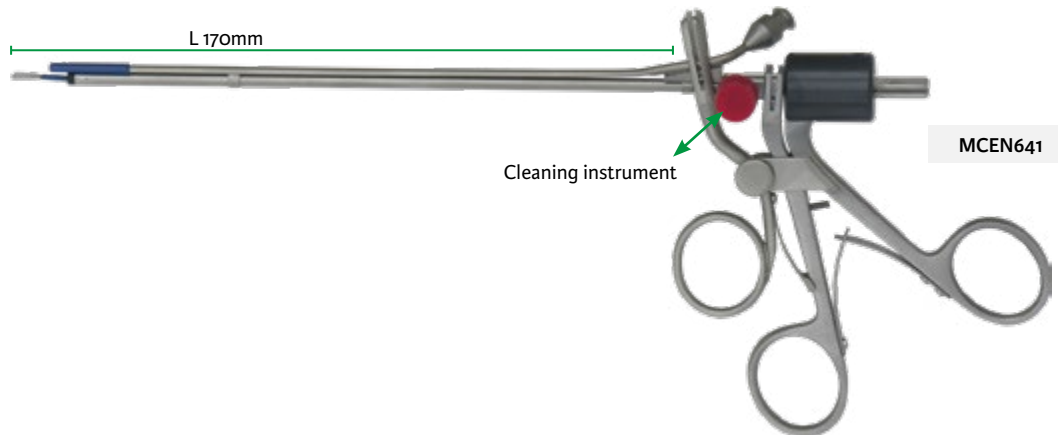
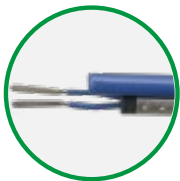

MCEN641

Wormald

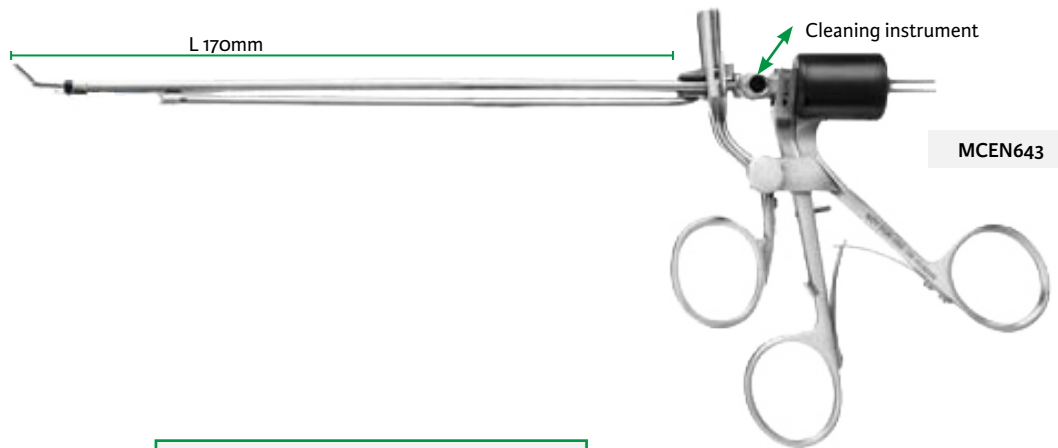

MCEN643

Bipolar cables - 4.5 m

<p>CP393-2 Bowa Emc Lamidey Valleylab</p>	
<p>CP393-3 Erbe VIO ICC ACC (except international) Storz Wolf</p>	
<p>CP393-4 Aesculap Berchtold Martin Sutter BM-780 II</p>	

Hook

Working length "L"

Scale 1/2

Frèche



90°

L 70mm



200mm

MCEN101

Herman



90° - 5mm

L 125mm



245mm

MCEN128

Suction tube elevator with finger control

Appelbaum



Ø2mm

L 65mm

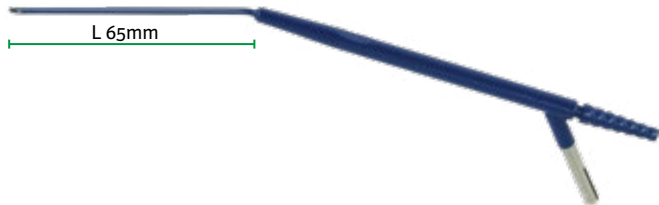

170mm

MCEN730

Suction tube with finger control

Frèche

MCEN100-2-0 2mm

MCEN100-2-5 2.5mm

MCEN100-3-0 3mm

MCEN100-3-5 3.5mm

L 145mm



200mm

MCEN100-2-5

Lancet knife

L 140mm

Frèche

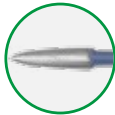

260mm

MCEN105

Picks

L 110mm

Rouvier



220mm

MCEN11

Rouvier



L 110mm

220mm

MCEN102

with suction

Monopolar cables - 3.5 m



CP391E

Erbe ACC ICC/VIO Storz Wolf



CP391M

Aesculap Berchtold Martin Erbe T Serie
Lamidey Sutter BM-780 II



CP391V

Bowa Bovie Conmed Valleylab

Drill with adjustable thrust



Scale 1/1 **7777** 85mm Ø 2mm

Hand drill



^(D) Distributed by Integra MicroFrance SAS (France)
For corresponding manufacturer part numbers, see table in annex

Working length "L"

Nail

Lemoine

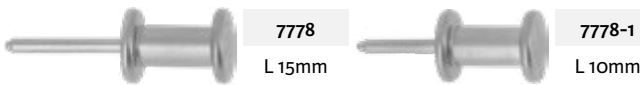

Scale 1/1

Klossek



Kennedy Instrumentation - 150mm length

Kennedy

Working length "L"

Scale 1/1

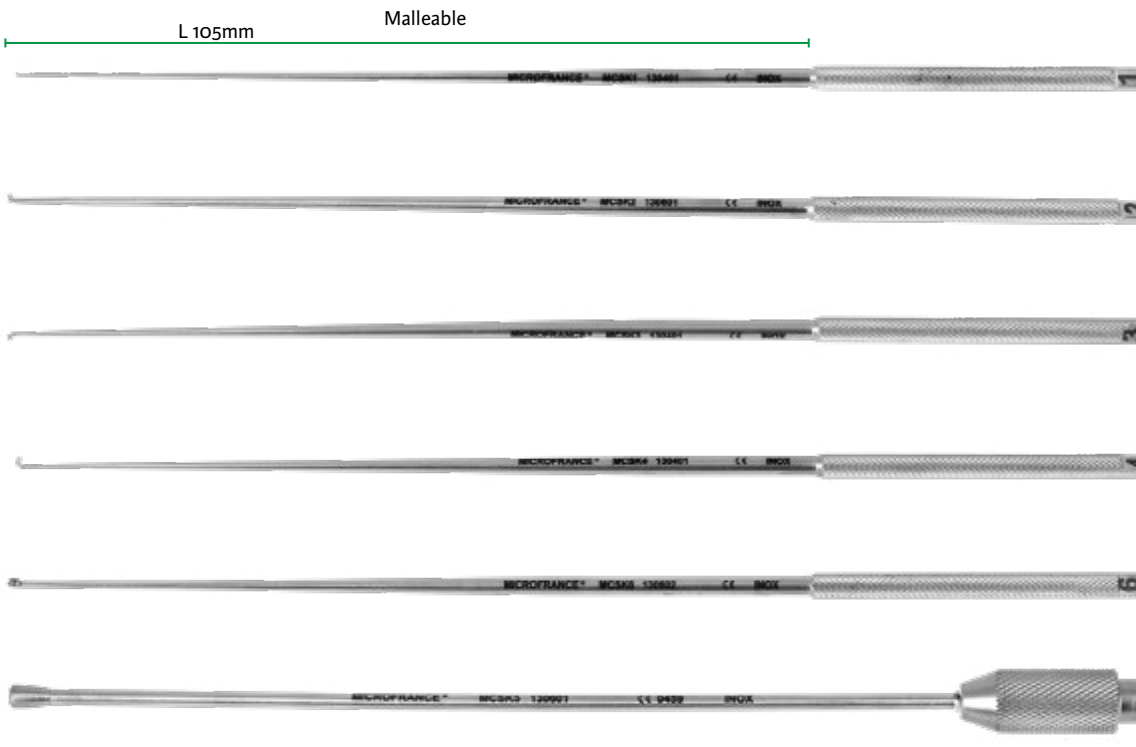

Palpation probe

MCSK1

Sharp hook

MCSK2

Blunt hook - 90°

MCSK3

Blunt hook - 150°

MCSK4

Curette - 1mm

MCSK6

Suction tube - 2mm

MCSK5

Knife and suction tube

Scale 1/2

Working length "L"

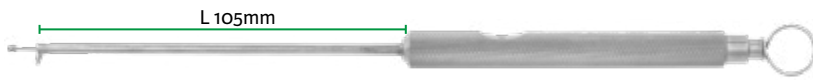

MCEN111
205mm



MCEN111 4mm - 80°	MCEN112 4mm - 90°	MCEN120 4mm - 135°
-----------------------------	-----------------------------	------------------------------

Thru-flow suction cup forceps

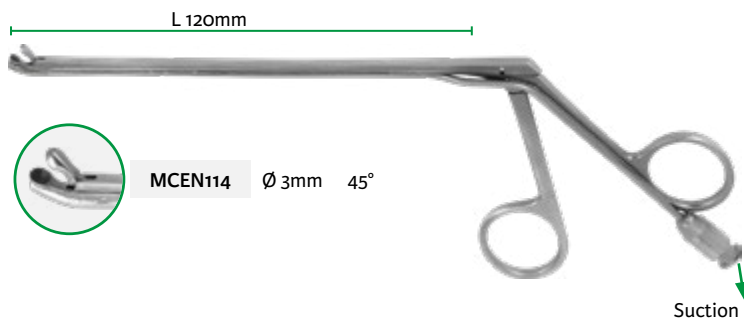

Suction tube with finger control 170mm length

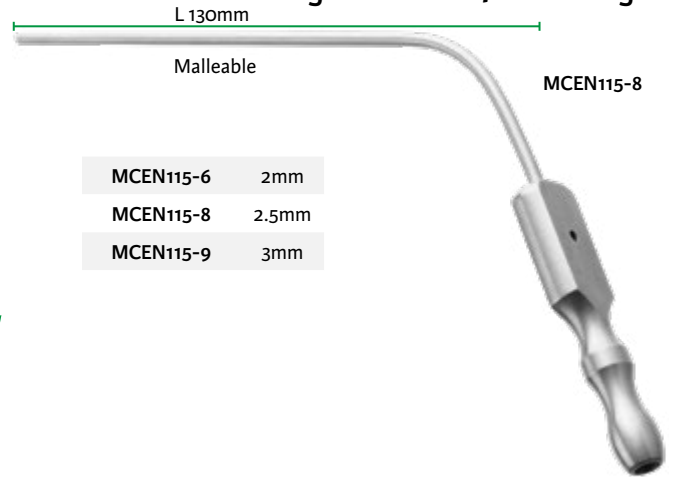

Cleaning device

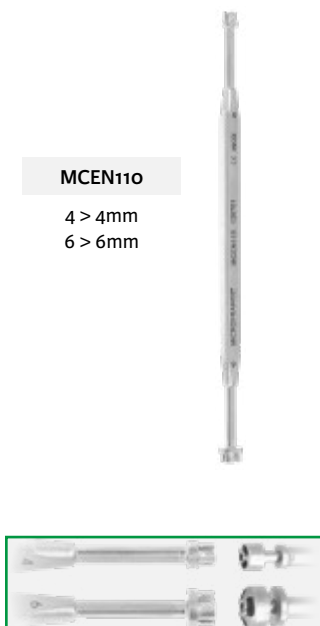

Cutting circular punch

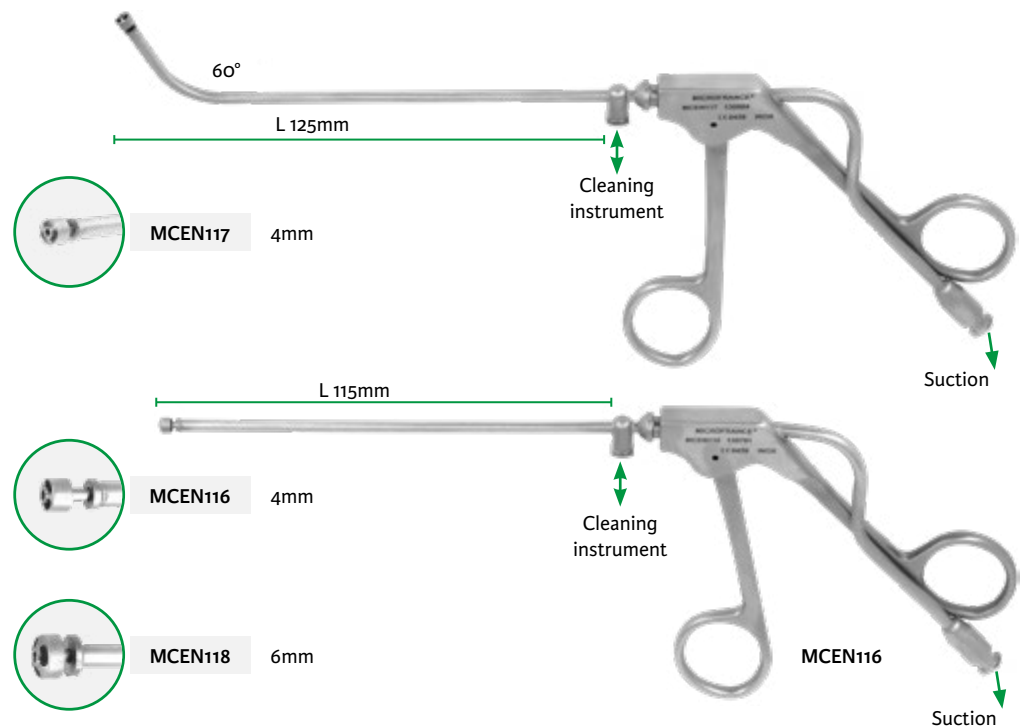

Scale 2/3

Suction curette with finger control

Working length "L"

150mm - Ø 3.5mm

MCEN768 Curette 90°

MCEN769 Curette 60°

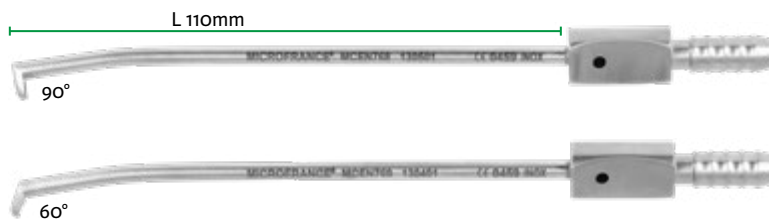

Double knife

190mm

MCEN720



240mm

MCEN760



240mm

MCEN761



Double palpation probe, Double ended seeker

Double-ended seeker

195mm

MCEN721



190mm

MCEN723



Double-ended palpation probe

245mm

MCEN762



245mm

MCEN763



Angled palpation probe



MCEN155 180mm

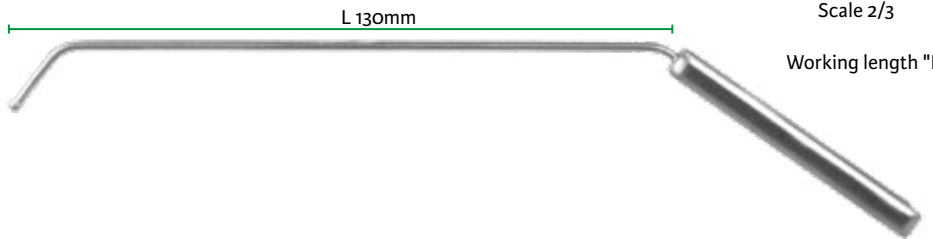

Scale 2/3
Working length "L"

Angled elevator



MCEN157 180mm

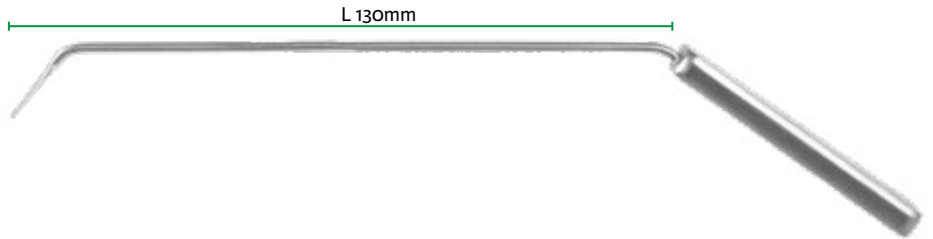

Blunt suction tube



MCEN156 185mm
Ø 2mm

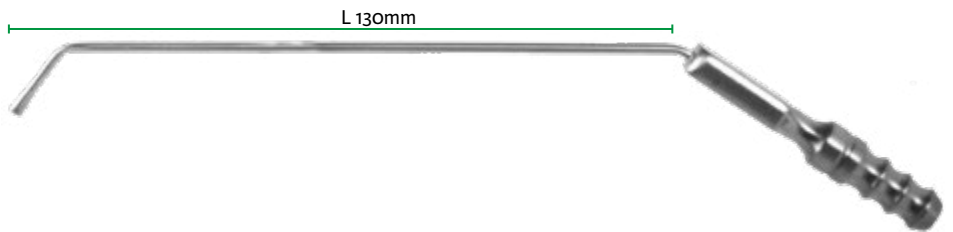

Angled suction tube elevator



MCEN158 185mm
Ø 2mm

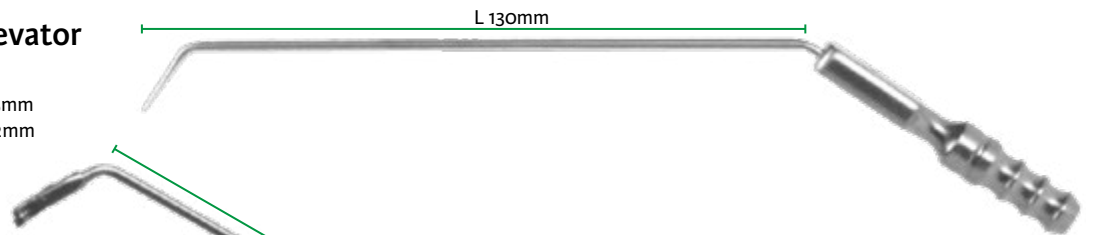

Cup forceps

curved down 45°



MCEN151
vertical



MCEN152
horizontal

Thru-cutting forceps



MCEN153
vertical



MCEN154
horizontal

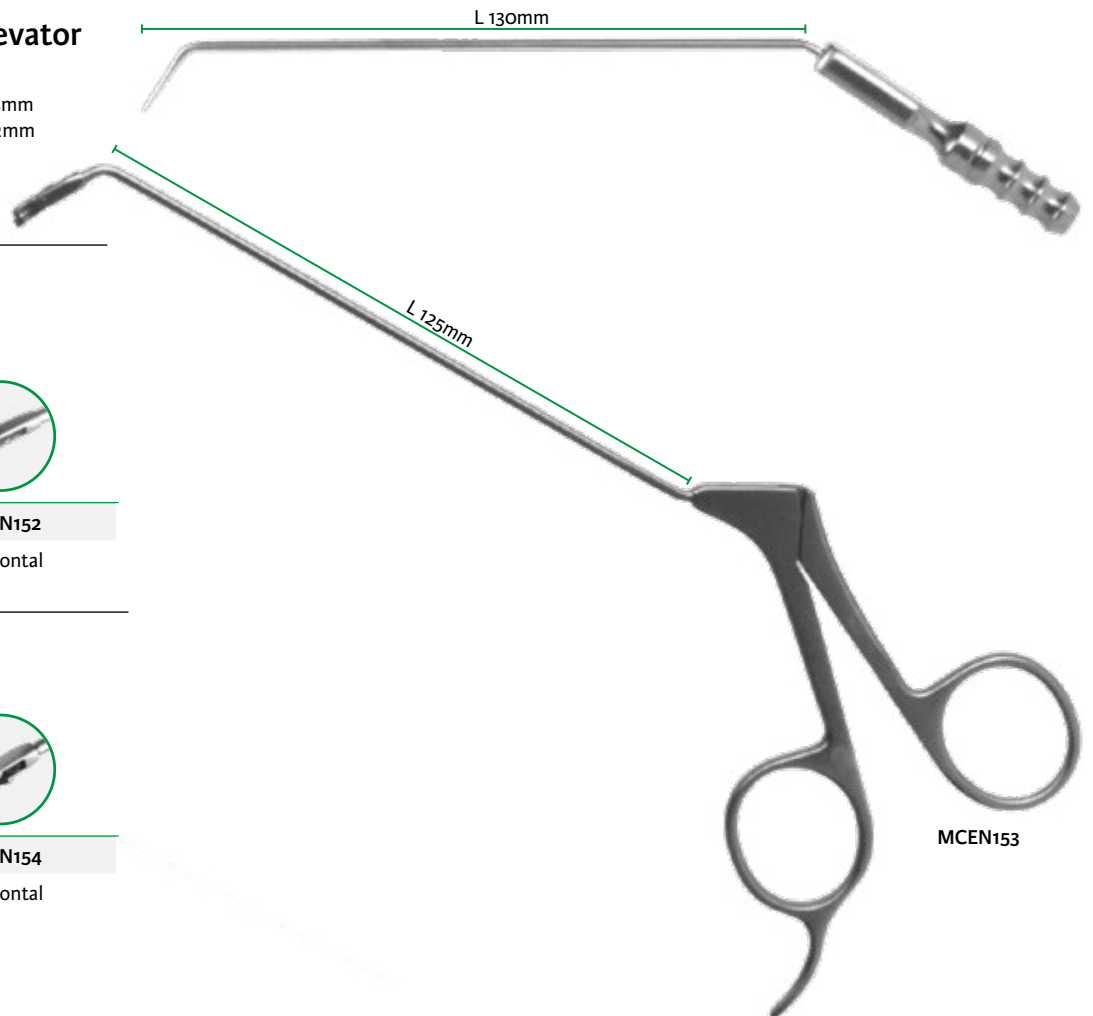

MCEN153

Scale 2/3

Working length "L"

Blunt loop, Knife and suction tube, suction curette

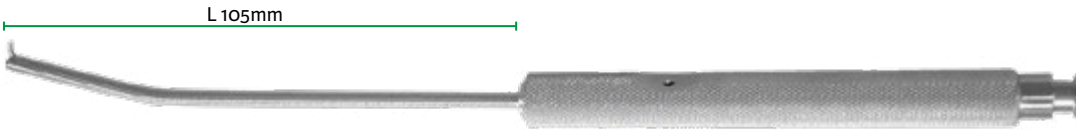

210mm
MCEN165



Blunt loop



Knife and suction tube



Suction curette

MCEN161	MCEN163	MCEN164	MCEN165	MCEN167
135° - Ø 3mm	90° - Ø 3mm	135° - Ø 3mm	45° - Ø 3mm	90° - Ø 3mm

Knife, Sickle knife, Loop, curved shaft



MCEN168



Knife
90°



Sickle knife
curved



Blunt loop
70°

MCEN162	MCEN168	MCEN170
180mm	225mm	250mm

Double ended perforator elevator



250mm
MCEN171

Perforator

Elevator



Forceps

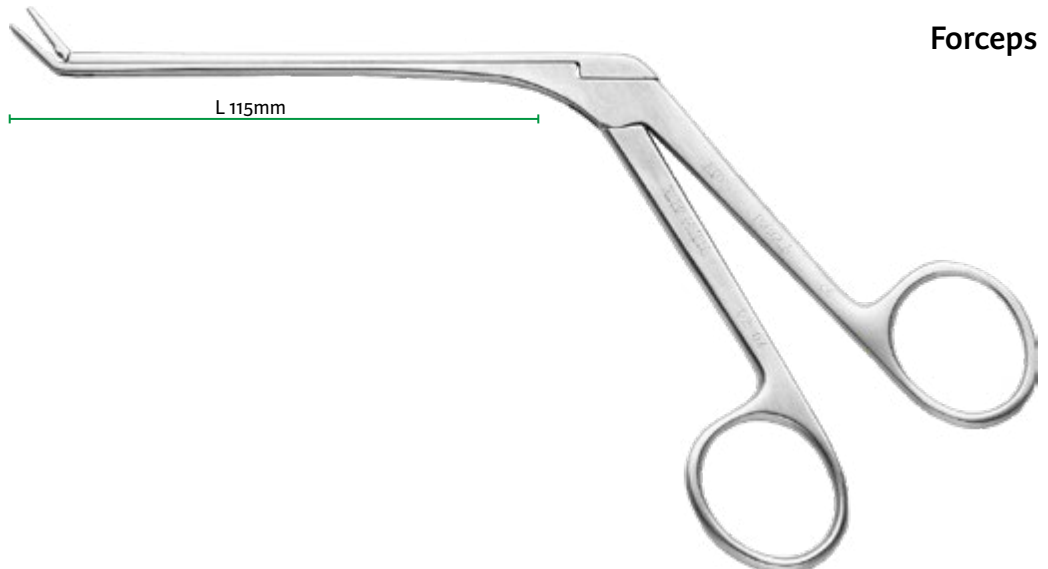

Serrated jaws

MCEN169
3x12mm

Palpation probe, Suction tube, Suction tube elevator

Scale 2/3

Working length "L"

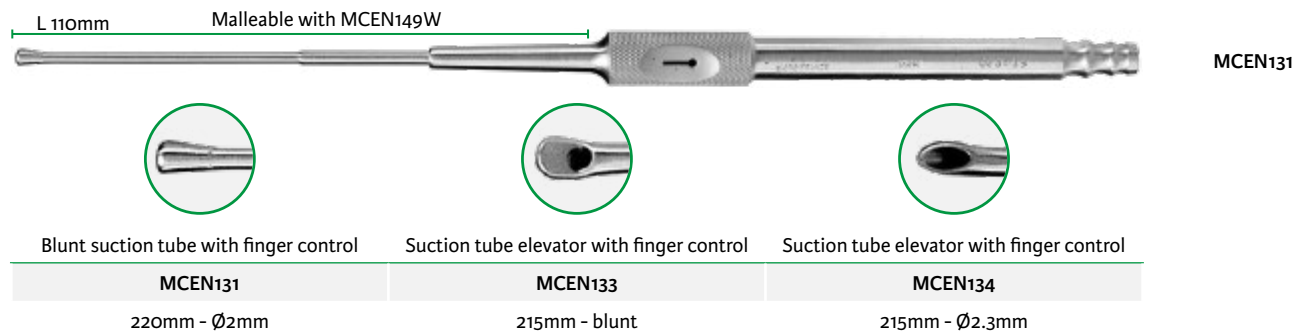
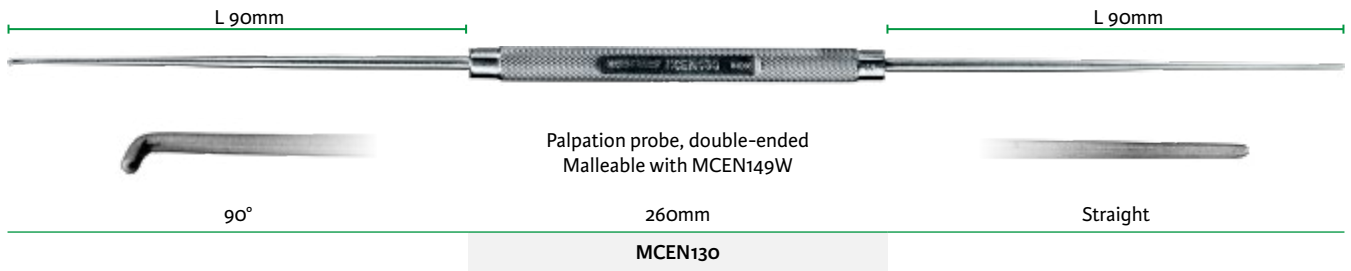

Knot pusher



Scale 1/2

Palpation probe, Suction curette, Basket suction tube, Suction tube elevator

Working length "L"



MCEN142

Suction tube with finger control



Suction curette with finger control



Basket suction tube with finger control



Suction tube elevator with finger control



MCEN138	MCEN138S	MCEN140	MCEN140A	MCEN141	MCEN141A	MCEN142	MCEN147
Ø 3.5mm	Ø 2mm	Ø 2.5mm	Ø 2.5mm	Ø 2.5mm	Ø 2.5mm	Ø 2.5mm	Ø 2.5mm
		45°	45°	90°	90°		
		4x5mm	5x6mm	4x5mm	5x6mm		



MCEN139A

Palpation probe



MCEN139	MCEN139A
90°	Straight



Suction tube modelling lever
MCEN149W
150mm

Scissors, forceps

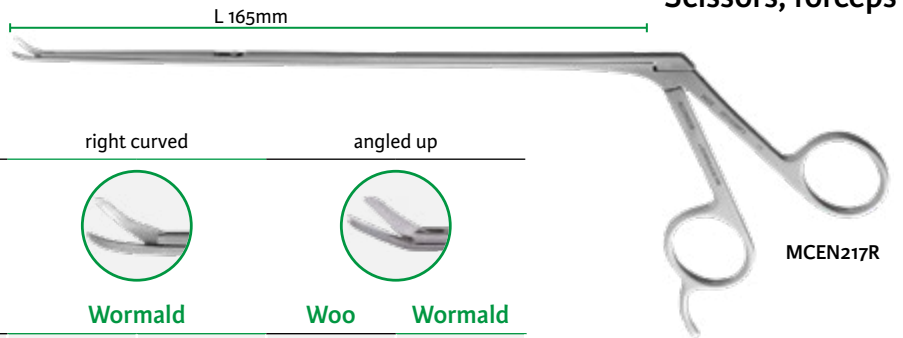

MCEN217R

Scissors

straight



left curved



right curved



angled up



Woo	Wormald	Wormald	Wormald	Woo	Wormald
MCLW10	MCEN217S	MCEN216L	MCEN217L	MCEN216R	MCEN217R
5mm	8mm	5mm	8mm	5mm	8mm

Fenestrated cup forceps, 230mm



MCEN214	MCEN215
straight jaws	45° jaws
1.5x3.5mm	1.5x3.5mm

Needle-holder, tungsten jaws

Scale 1/2

Working length "L"

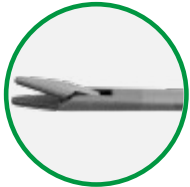

MCEN218

tungsten

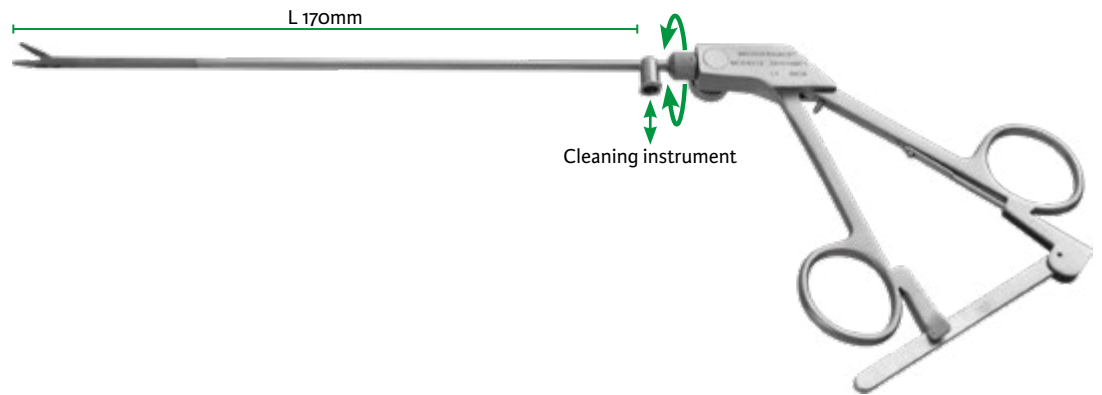

Debaquey clamp, rotatable

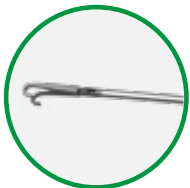

MCEN191



MCEN192

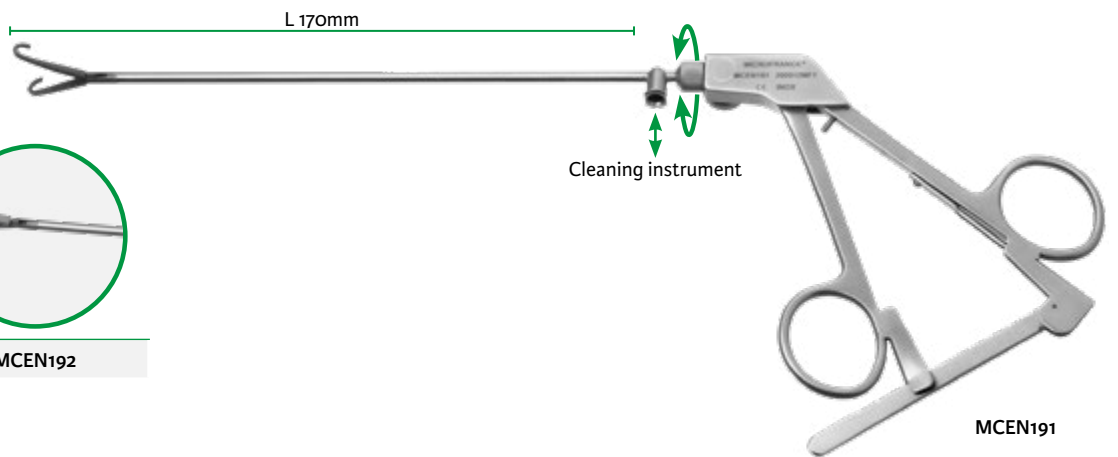

MCEN191



MCEN190

Straight, angled shaft
20°

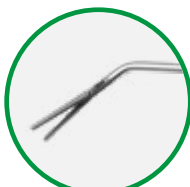

MCEN193

Straight, angled shaft
45°

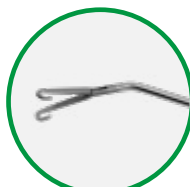

MCEN194

Curved, angled shaft
45°

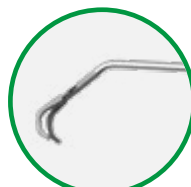

MCEN195

Curved, angled shaft
45°

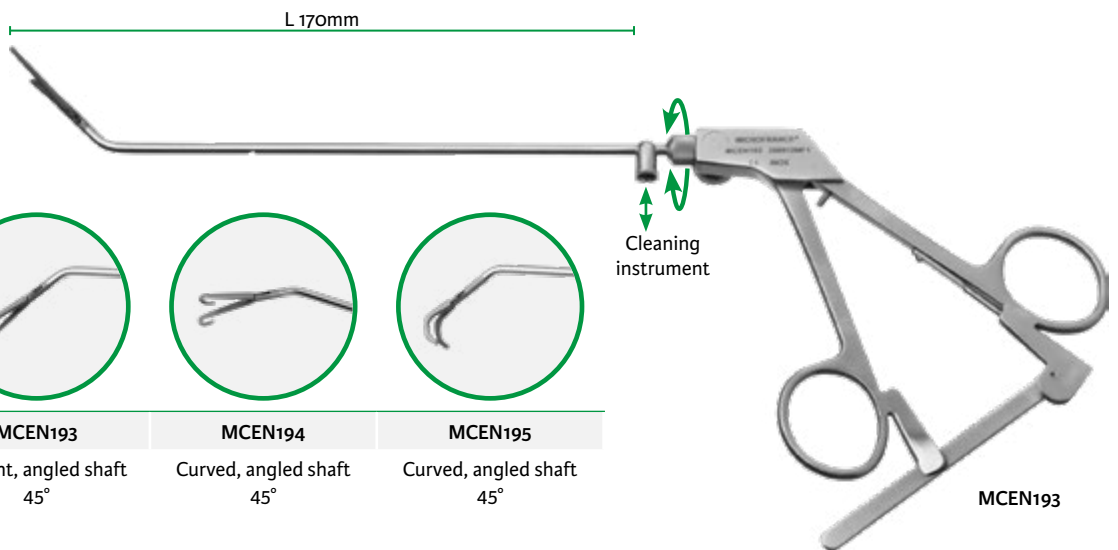

MCEN193

Scale 1/2

Working length "L"

Suction tube with finger control



210mm
MCEN349

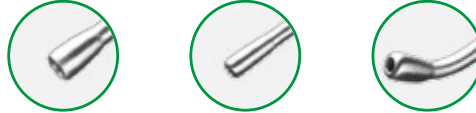

MCEN347	MCEN348	MCEN349
Ø 2mm	Ø 1.5mm	Ø 2mm

Suction tube , angulated

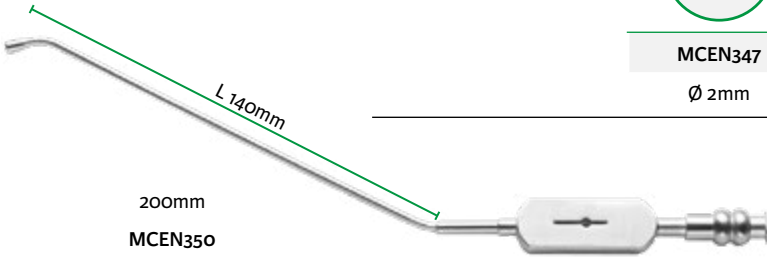

MCEN350	MCEN351
curved down Ø 2mm	curved up Ø 2mm

Hook, Ball probe, Elevator



230mm
MCEN345

Hook Ball probe Elevator



MCEN329	MCEN330	MCEN345	MCEN346
Ø 1.5mm	Ø 3mm	Ø 2mm	Ø 4mm

Cup forceps, scissors, bipolar forceps with stylet handle

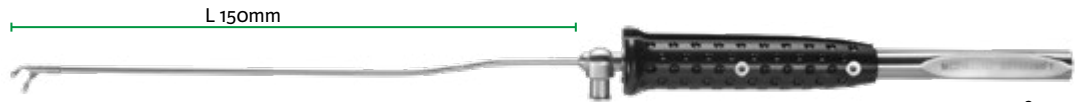

280mm
MCEN328U

Cup forceps



MCEN328S
straight
Ø 2.5mm



MCEN328U
up
Ø 2.5mm

Scissors



MCEN344S
5mm - straight



MCEN344U
5mm - 45°



MCEN344V
5mm - curved left

280mm
MCEN344U

Bipolar forceps

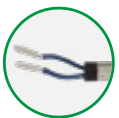

MCEN364
45° - 1x5mm

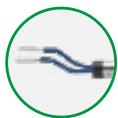

MCEN365
Bayonet jaws

300mm
MCEN365

Bipolar cables - 4.5 m

CP393-2
Bowa Emc
Lamidey
Valleylab



CP393-3
Erbe VIO ICC
ACC (except
international)
Storz Wolf



CP393-4
Aesculap
Berchtold
Martin Sutter
BM-780 II





Scale 1/2

Stainless steel cup

7876-60^(D)	60mm
7876-80^(D)	80mm
7876-100^(D)	100mm
7876-120^(D)	120mm
7876-160^(D)	160mm



Stainless steel tray

7872-24^(D)	240x180mm
------------------------------	-----------

Scale 1/4



Surgical instrument paraffin oil

MCO731^(D)

Stainless steel sterilization case

Scale 1/5



7874MF-22

240x105x45mm
220x100x40mm

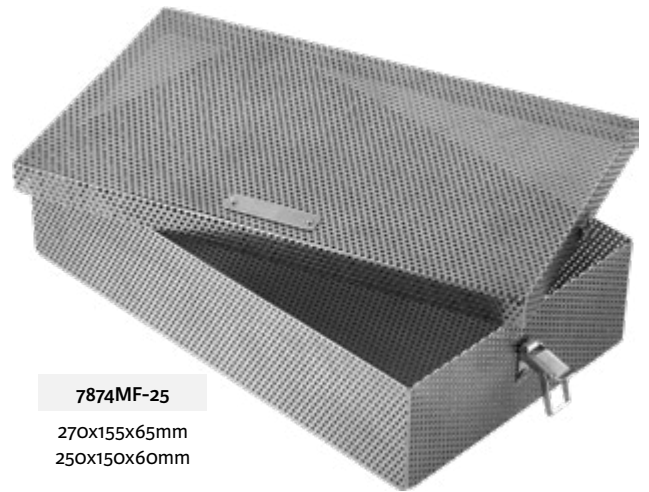

7874MF-25

270x155x65mm
250x150x60mm

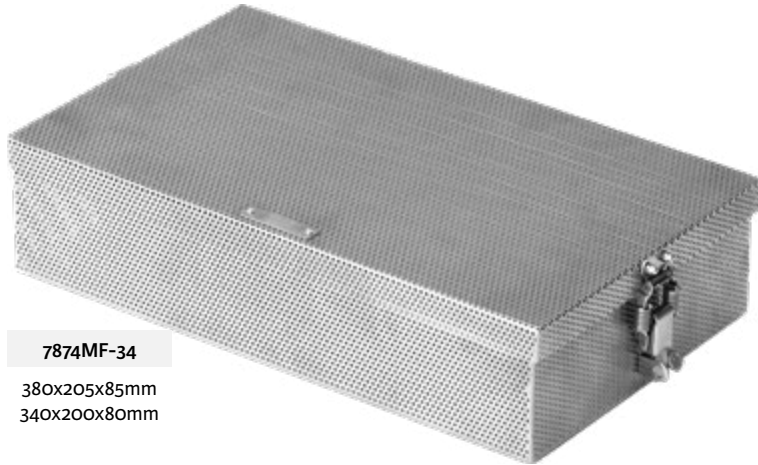

7874MF-34

380x205x85mm
340x200x80mm

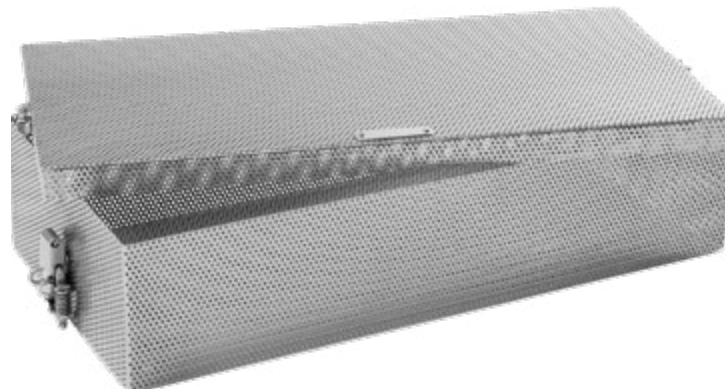

7874MF-40

440x205x95mm - 400x200x90mm

^(D) Distributed by Integra MicroFrance SAS (France) - For corresponding manufacturer part numbers, see table in annex

Numerical index

1

1003IG ^(D)	14
1003LI ^(D)	14
1004IG ^(D)	14
1005I ^(D)	14
1352431.....	77
1375012.....	73
1375020.....	73
1375025.....	73
1375101.....	73
1375102.....	73
1375103.....	73
1375107.....	73
1375110.....	73
1375114.....	73
1375201.....	73
1375207.....	73
1375210.....	73
1375214.....	73

3

3714024.....	19
3714025.....	19
3714026.....	19
3714027.....	20
3714028.....	20
3714055.....	28
3714056.....	28
3714057.....	28
3714058.....	28
3714096.....	33
3714098.....	30
3714099.....	30
3714107.....	19
3714108.....	19
3714109.....	19
3714111.....	19
3714148.....	37
3714149.....	37
3714164.....	15
3714166.....	15
3714182.....	22
3714183.....	22
3714187.....	22
3714320.....	28
3714364.....	19
3714379.....	76
3714678.....	15
3724059.....	16
3724256.....	19

7

702T.....	64
703T.....	64
704T.....	64
713T.....	54
714T.....	64
1003IG(D).....	14
1003LI(D).....	14
1004IG(D).....	14
1005I(D).....	14
7706MF.....	2
7717C.....	2
7719-2.....	3
7722-3.....	2
7726MF.....	7
7727.....	7
7728.....	7
7731.....	3
7732-1.....	7
7733.....	7
7734.....	7
7742-1.....	2
7742-2.....	2
7742-3.....	2
7746A(D).....	2
7746B(D).....	2
7749.....	8
7750.....	8
7761-1.....	8
7761-2.....	8
7761B-1.....	8
7761B-2.....	8
7761BC1.....	8
7761BC2.....	8
7761BC3.....	8
7761C1.....	8
7761C2.....	8
7761C3.....	8
7762-1.....	83
7762-2.....	83
7762-5.....	79
7762A-1.....	83
7762A-2.....	83
7762A4.....	81
7762A-5.....	79
7762B-1.....	83
7763.....	84
7763-1.....	84
7764.....	40
7765.....	44
7766.....	26
7768.....	18
7768-1.....	18
7771.....	75
7771AS10(D).....	75

7771B.....	75
7774.....	24
7776(D).....	97
7777.....	97
7778.....	97
7778K.....	97
7778K1.....	97
7779MF-1.....	9
7779MF-2.....	9
7779MF-3.....	9
7779MF-5CC.....	9
7782-1-2.....	20
7783-12.....	9
7787-10.....	16
7831A-12.....	55
7831A-15.....	57
7831A-18.....	59
7831A-20.....	61
7832.....	61
7833A-12.....	55
7833A-15.....	57
7833A-18.....	60
7833A-20.....	61
7834.....	61
7866-13.....	68
7867-1.....	65
7867-2.....	65
7867-3.....	65
7867-4.....	65
7872-24(D).....	106
7874MF-22.....	106
7874MF-25.....	106
7874MF-34.....	106
7874MF-40.....	106
7876-60(D).....	106
7876-80(D).....	106
7876-100(D).....	106
7876-120(D).....	106
7876-160(D).....	106
7881.....	2
7882.....	2
7896-1.....	2
7896-2.....	2
7896-3.....	2
7897.....	4
7898.....	4
7899.....	4
7903-50-5(D).....	9

A

AQ1728(D).....	38
----------------	----

CEV

CEV669BG.....	94
---------------	----

^(D) Distributed by Integra MicroFrance SAS (France) - For corresponding manufacturer part numbers, see table in annex

CEV984..... 6
 CEV985..... 6

CP

CP16..... 45
 CP16-1..... 45
 CP17..... 18
 CP17-1..... 18
 CP17-2..... 18
 CP17-3..... 18
 CP21-3..... 20
 CP21A-3..... 20
 CP23-4..... 22
 CP23-6..... 22
 CP23-8..... 22
 CP23-10..... 22
 CP23A-8..... 22
 CP37..... 55
 CP291..... 35
 CP300..... 27
 CP301-1..... 34
 CP301-2..... 35
 CP301-3..... 35
 CP301-4..... 36
 CP301-5..... 36
 CP301-9..... 36
 CP301-10..... 36
 CP302-2..... 25
 CP302-3..... 25
 CP302-4..... 25
 CP302-5..... 25
 CP302-6..... 25
 CP302-8..... 25
 CP304-2..... 29
 CP304-3..... 29
 CP304-4..... 29
 CP304-5..... 29
 CP304-6..... 29
 CP304-7..... 29
 CP304-8..... 29
 CP304-9..... 29
 CP304-10..... 29
 CP304-11..... 29
 CP304-12..... 29
 CP304-14..... 29
 CP304-15..... 29
 CP304-16..... 29
 CP304B-2..... 29
 CP304B-3..... 29
 CP304B-4..... 29
 CP304B-5..... 29
 CP304B-6..... 29
 CP304B-8..... 29
 CP304B-10..... 29

CP304B-12..... 29
 CP305..... 30
 CP305L..... 30
 CP305R..... 30
 CP306..... 22
 CP309-8-12..... 31
 CP309-10-14..... 31
 CP309-12-16..... 31
 CP309-14-16..... 31
 CP309-14-18..... 31
 CP310..... 17
 CP310D..... 17
 CP310E..... 17
 CP313..... 32
 CP313-1..... 32
 CP314-14..... 31
 CP315..... 30
 CP315D..... 30
 CP315G..... 30
 CP316..... 30
 CP317..... 29
 CP318..... 29
 CP330-3-0..... 69
 CP330-4-0..... 69
 CP331..... 21
 CP331-1..... 21
 CP332..... 55
 CP333..... 15
 CP335..... 20
 CP337..... 13
 CP337-1..... 13
 CP338..... 21
 CP339..... 21
 CP340..... 21
 CP341..... 21
 CP344A..... 17
 CP344AT..... 17
 CP344B..... 17
 CP344BT..... 17
 CP344C..... 17
 CP344CT..... 17
 CP344D..... 17
 CP344DT..... 17
 CP344E..... 17
 CP344ET..... 17
 CP345..... 58
 CP348..... 53
 CP350..... 54
 CP351-2..... 51
 CP351-3..... 51
 CP351-6..... 51
 CP351-7..... 51
 CP352..... 52
 CP352-1..... 52
 CP352-2..... 52

CP352-3..... 52
 CP353..... 45
 CP354..... 46
 CP354A..... 46
 CP355..... 47
 CP355A..... 47
 CP355C..... 50
 CP356..... 45
 CP358..... 45
 CP358A..... 45
 CP359..... 53
 CP360..... 54
 CP362..... 46
 CP363..... 48
 CP365..... 50
 CP367..... 47
 CP367-1..... 47
 CP380..... 41
 CP380-1..... 41
 CP380-2..... 41
 CP380-3..... 41
 CP380-5..... 41
 CP381..... 43
 CP390-1..... 63
 CP390-2..... 63
 CP390-8..... 63
 CP391E..... 63, 96
 CP391M..... 63, 96
 CP391V..... 63, 96
 CP392-1R..... 62
 CP392-2R..... 62
 CP392-8R..... 62
 CP392BI..... 62
 CP392BS..... 62
 CP393-2..... 62, 94, 95, 105
 CP393-3..... 62, 94, 95, 105
 CP393-4..... 62, 94, 95, 105
 CP400..... 57
 CP400-1..... 55
 CP400-2..... 60
 CP401..... 58
 CP406..... 55
 CP407..... 57
 CP409..... 59
 CP414..... 55
 CP415..... 57
 CP604..... 56
 CP604-15..... 56
 CP604BR..... 62
 CP604M..... 63
 CP605..... 56
 CP605-15..... 56
 CP605BR..... 62
 CP605M..... 63
 CP606..... 56

^(D) Distributed by Integra MicroFrance SAS (France) - For corresponding manufacturer part numbers, see table in annex

MCEN62B1DG	80	MCEN91DG	80	MCEN161	101
MCEN62B2	81	MCEN96	85	MCEN162	101
MCEN62B2DG	80	MCEN97	85	MCEN163	101
MCEN62B3	81	MCEN98	91	MCEN164	101
MCEN62T1	81	MCEN99	85	MCEN165	101
MCEN62T1DG	80	MCEN100-2-0	96	MCEN167	101
MCEN62T2	81	MCEN100-2-5	96	MCEN168	101
MCEN62T2DG	80	MCEN100-3-0	96	MCEN169	101
MCEN62T3	81	MCEN100-3-5	96	MCEN170	101
MCEN64	95	MCEN101	96	MCEN171	101
MCEN65	90	MCEN102	96	MCEN183	72
MCEN66	90	MCEN103	78	MCEN184	72
MCEN67	90	MCEN103LDG	71	MCEN186	72
MCEN67-1	90	MCEN104	24	MCEN187	12
MCEN67-2	90	MCEN105	96	MCEN190	104
MCEN68	86	MCEN106	24	MCEN191	104
MCEN68ADG	80	MCEN107	24	MCEN192	104
MCEN68BDG	80	MCEN109	24	MCEN193	104
MCEN68CDG	80	MCEN110	98	MCEN194	104
MCEN77-3-0	72	MCEN111	98	MCEN195	104
MCEN77-3-5	72	MCEN112	98	MCEN211	93
MCEN78J30	72	MCEN114	98	MCEN211S	93
MCEN78J40	72	MCEN115-6	98	MCEN212	93
MCEN79J25	72	MCEN115-8	98	MCEN212S	93
MCEN79J30	72	MCEN115-9	98	MCEN213	93
MCEN79J40	72	MCEN116	98	MCEN213S	93
MCEN81-C	74	MCEN117	98	MCEN214	103
MCEN81O	74	MCEN118	98	MCEN215	103
MCEN81O1	74	MCEN120	98	MCEN216L	103
MCEN81O2	74	MCEN127	78	MCEN216R	103
MCEN81-S	74	MCEN128	96	MCEN217L	103
MCEN81-W	74	MCEN130	102	MCEN217R	103
MCEN82-C	74	MCEN131	102	MCEN217S	103
MCEN82O	74	MCEN133	102	MCEN217U	103
MCEN82O5	74	MCEN134	102	MCEN218	104
MCEN82O6	74	MCEN135	102	MCEN328S	105
MCEN82-S	74	MCEN138	103	MCEN328U	105
MCEN82-W	74	MCEN138S	103	MCEN329	105
MCEN83-C	74	MCEN139	103	MCEN330	105
MCEN83O	74	MCEN139A	103	MCEN344S	105
MCEN83OL	74	MCEN140	103	MCEN344U	105
MCEN83-S	74	MCEN140A	103	MCEN344V	105
MCEN83-W	74	MCEN141	103	MCEN345	105
MCEN84S(D)	74	MCEN141A	103	MCEN346	105
MCEN87C	74	MCEN142	103	MCEN347	105
MCEN87O3	74	MCEN147	103	MCEN348	105
MCEN87O4	74	MCEN149W	102, 103	MCEN349	105
MCEN87-S	74	MCEN151	100	MCEN350	105
MCEN87W	74	MCEN152	100	MCEN350H	81
MCEN88SC	74	MCEN153	100	MCEN350V	81
MCEN90	79	MCEN154	100	MCEN351	105
MCEN90DG	80	MCEN155	100	MCEN360H	81
MCEN91	79	MCEN156	100	MCEN360V	81
MCEN91B	79	MCEN157	100	MCEN364	105
MCEN91BDG	80	MCEN158	100	MCEN365	105

MCEN371D4.....	71
MCEN371D35.....	71
MCEN641.....	95
MCEN643.....	95
MCEN713.....	77
MCEN720.....	99
MCEN721.....	99
MCEN723.....	99
MCEN728DG.....	80
MCEN730.....	96
MCEN760.....	99
MCEN761.....	99
MCEN762.....	99
MCEN763.....	99
MCEN764.....	12
MCEN765.....	12
MCEN766.....	72
MCEN767.....	72
MCEN768.....	99
MCEN769.....	99
MCEN770B25.....	71
MCEN770B30.....	71
MCEN770J30.....	69
MCEN770J40.....	69
MCEN960H.....	81

MCL

MCL38N.....	7
MCL75.....	7
MCL170 ^{(D)(i)}	7
MCL171 ^{(D)(i)}	7
MCL173 ^{(D)(i)}	7
MCL174 ^{(D)(i)}	7
MCL197 ^{(D)(i)}	7

MCLW

MCLW10.....	103
MCLW11.....	103

MCO

MCO1B.....	70
MCO201-2-5.....	69
MCO201-3-0.....	69
MCO214-13-10.....	28
MCO214-13-20.....	28
MCO214-13-40.....	28
MCO214-13-60.....	28
MCO214-13-80.....	28
MCO233.....	4
MCO237.....	4
MCO305.....	10
MCO311-1-0.....	70

MCO311-1-2.....	70
MCO311-1-5.....	70
MCO311-1-8.....	70
MCO311-2-0.....	70
MCO311-2-5.....	70
MCO311-3-0.....	70
MCO311-3-5.....	70
MCO311-4-0.....	70
MCO731(D).....	106
MCO770-1-5.....	69
MCO770-2-0.....	69
MCO770-2-5.....	69
MCO770-3-0.....	69
MCO770-3-5.....	69
MCO770-4-0.....	69
MCO771-2-5.....	69
MCO771-3-0.....	69
MCO771-4-0.....	69
MCO772.....	70
MCO775-1.....	70
MCO776.....	70
MCO803.....	10
MCO805.....	3
MCO805A.....	3
MCO807.....	3
MCO950.....	3
MCO978.....	6
MCO978S.....	6
MCO979.....	16
MCO980.....	6
MCO981.....	6
MCO981D.....	6
MCO983-4.....	6
MCO988.....	16
MCO995.....	26

MCSK

MCSK1.....	97
MCSK2.....	97
MCSK3.....	97
MCSK4.....	97
MCSK5.....	97
MCSK6.....	97

P

P761-7.....	65
P761-8.....	65
P762-2.....	66
P762-4.....	66
P763.....	67
P764-1.....	66
P764-3.....	66
P764-5.....	66

P764-7.....	66
P764-11.....	66
P765-14.....	67
P765-16.....	67
P769.....	67

S

SCP337A.....	13
--------------	----

^(D) Distributed by Integra MicroFrance SAS (France) - For corresponding manufacturer part numbers, see table in annex



**Table for corresponding
manufacturer part numbers
For information purposes only**

Integra MicroFrance® product reference	Corresponding manufacturer part number
1003IG	M3IG
1003LI	M3LI
1004IG	M4IG
1005I	M5I
7746A	651
7746B	650
7771AS10	A 1908S
7776	76.51.20
7872-24	1224
7876-100	310
7876-120	312
7876-160	316
7876-60	306
7876-80	308
7903-50-5	13.202
AQ1728	PS-1728
MCEN84S	MCEN84S
MCL38N	EC-BLU50U090
MCL170 ⁽¹⁾	CO101
MCL171 ⁽¹⁾	CO201
MCL173 ⁽¹⁾	CO100
MCL174 ⁽¹⁾	CO200
MCL197 ⁽¹⁾	CO103
MCO731	430490

⁽¹⁾ Not a medical device

Manufacturers:



Integra MicroFrance SAS (France)
Le Pavillon ■ 03160 Saint Aubin le Monial ■ France

Manufacturers with CE Class I products only:



Swann Morton Ltd
Penn Works ■ Owlerton Green ■ Sheffield
South Yorkshire S6 2BJ ■ Royaume Uni



Sunoptic Technologies®, LLC
6018 Bowdendale Avenue
Jacksonville ■ FL 32216 USA



HEMODIA SAS
85, rue du Chêne Vert
31670 LABEGE ■ France



Concorde Import Export
B.P. 37
92300 Levallois-Perret ■ France



Unimed SA
Rue du Grand-Pré 10
1007 Lausanne ■ Suisse



Medicon eG
Gaensaecker 15
D-78832 Tuttlingen ■ Allemagne



Agencinox
Zone Industrielle
89110 Aillant sur Tholon ■ France



Chemische Fabrik Dr. Weigert GmbH & Co.
Mühlenhagen
D-20539 Hamburg ■ Allemagne



Medical device & QA Services Ltd
76, Stockport Road ■ Timperley
Cheshire ■ WA15 75N ■ Royaume Uni



Qfix
440 Church Road
Avondale ■ PA 19311 USA



RMS - UK Limited
28 Trinity Road ■ Nailsea
Somerset ■ BS48 4NU ■ Royaume Uni

Availability of these products might vary from a given country or region to another, as a result of specific local regulatory approval or clearance requirements for sale in such country or region.

- Consult product labels and inserts for any indications, contraindications, hazards, warnings, precautions, and instructions for use.
- Non contractual document. The manufacturer reserves the right, without prior notice, to modify the products in order to improve their quality.
- Warning: Applicable laws restrict these products to sale by or on the order of a physician.

Additional information for EMEA Customers only :

Products mentioned in this document are CE class I, Im, IIa or IIb devices. Contact Integra should you need any additional information on devices classification. All the medical devices mentioned on this document are CE marked according to European council directive 93/42/EEC on medical devices and its relatives. References that are not medical devices are identified with the indication "NOT A MEDICAL DEVICE".

Products marked with the symbol ^(®) are distributed by Integra MicroFrance SAS (France)

Date of last révision : 12/2020

For more information, please contact customer service :



PRIM S. A.
C/ Yolanda González, nº 1 5
28938 - Móstoles (Madrid)
Tlf. 91 334 24 41 - orl@prim.es

Integra and the Integra logo are registered trademarks of Integra LifeSciences Corporation or its subsidiaries in the United States and/or other countries.

MicroFrance is a trademark of Integra LifeSciences Corporation or its subsidiaries. All other trademarks and product names are the property of their respective owners.

© 2020 Integra LifeSciences Corporation. All rights reserved.

0332452-4-EN

DOCUMENT FOR USE IN EUROPE, MIDDLE-EAST AND AFRICA ONLY.